

# REPORT

## **FCR-D design of requirements – phase 2**

**VERSION 1 - 13 JANUARY 2019**

### **AUTHORS**

Evert Agneholm	DNV GL
Soroush Afkhami Meybodi	Energinet
Mikko Kuivaniemi	Fingrid
Pia Ruokolainen	Fingrid
Jon Nerbø Ødegård	Statnett
Niklas Modig	Svenska kraftnät
Robert Eriksson	Svenska kraftnät

# Contents

<b>1. INTRODUCTION.....</b>	<b>5</b>
1.1 BACKGROUND OF THE PROJECT .....	5
1.2 FRAMEWORK FOR THE WORK .....	5
1.3 GOALS.....	6
1.4 OUTLINE .....	6
<b>2. REVISED REQUIREMENTS FOR FCR-D.....</b>	<b>7</b>
2.1 FRAMEWORK .....	7
2.2 RELAXING THE REQUIREMENTS.....	7
2.3 CAPACITY EVALUATION.....	11
2.3.1 INSTALLED CAPACITY.....	11
2.3.2 SIMULATION RESULTS .....	12
2.3.3 APPROACH .....	12
2.4 FINDING THE PERFORMANCE REQUIREMENTS AT DIFFERENT LEVELS OF KINETIC ENERGY .....	16
2.5 QUALIFIED FCR-D CAPACITY PER COUNTRY .....	19
2.5.1 NORWAY .....	19
2.5.2 SWEDEN .....	21
2.5.3 FINLAND .....	23
2.6 CLOSED LOOP STABILITY .....	24
2.6.1 STABILITY REQUIREMENT AND REGULATING STRENGTH .....	24
2.6.2 SENSITIVITY ANALYSIS OF THE STABILITY REQUIREMENT.....	26
2.7 STABILITY EVALUATION FOR SATURATING UNITS .....	27
2.7.1 BACKGROUND.....	27
2.7.2 SOLUTION .....	31
2.7.3 REQUIREMENT .....	32
2.7.4 PREQUALIFICATION .....	33
2.8 CONCLUSION AND DISCUSSION.....	33
2.9 FURTHER WORK.....	34
<b>3. SWITCH OVER BETWEEN FCR-N AND FCR-D .....</b>	<b>36</b>
3.1 BACKGROUND.....	36
3.1.1 EVALUATION .....	36
3.1.2 TWO PRODUCTS .....	37
3.1.3 CASES .....	38
3.2 SIMULATION RESULTS .....	43
3.2.1 STEADY STATE .....	43
3.2.2 DYNAMIC PARAMETERS .....	46
3.3 CONCLUSION .....	54
3.4 REQUIREMENTS.....	54
3.5 PREQUALIFICATION .....	55
<b>4. FULL-SCALE SIMULATIONS.....</b>	<b>57</b>
4.1 INTRODUCTION .....	57
4.2 FULL-SCALE SIMULATION MODEL.....	58
4.2.1 POWER SYSTEM STABILIZERS.....	58
4.2.2 MODEL UPDATES .....	59
4.2.3 MODEL PARAMETERIZATION .....	61
4.3 STUDIES PERFORMED .....	65
4.3.1 DISTURBANCES.....	65
4.3.2 POWER FLOWS.....	65
4.3.3 SIMULATIONS .....	67
4.4 RESULTS .....	68

4.5 CONCLUSIONS..... 78

**5. CONCLUSIONS .....79**

**6. REFERENCES .....81**

**7. APPENDIXES .....82**

**ABBREVIATIONS AND SYMBOLS****Abbreviations**

EPC	Emergency Power Control
FCP	Frequency Containment Process
FCR	Frequency Containment Reserve
FCR-D	Frequency Containment Reserve for Disturbances
FCR-N	Frequency Containment Reserve for Normal operation
FFR	Fast Frequency Reserve
HVDC	High Voltage Direct Current
KPI	Key Performance Indicator
PID-controller	Proportional-Integral-Derivative-controller
pu	Per unit
RoCoF	Rate of Change of Frequency
SISO	Single Input Single Output
TSO	Transmission System Operator

**Symbols**

$BL$	Backlash
$C_{FCR-D}$	Capacity scaling of FCR-D
$df/dt$	Frequency derivative
$E_{kp}$	Design kinetic energy for performance
$E_{ks}$	Design kinetic energy for stability
$e_p$	Droop
$f_0$	Nominal frequency
$F_0(s)$	Transfer function of normalised unit response
$F(s)$	Transfer function of unit response
$k$	Frequency dependency of loads
$K_p$	Proportional gain
$K_i$	Integral gain
$K_d$	Derivative gain
$L(s)$	Transfer function of open loop system
$M_s$	Stability margin
$M_{s,req}$	Required stability margin
$\Delta P_{\text{disturbance}}$	Power imbalance
$P_{\text{installed}}$	Installed power
$P_{\text{set}}$	Setpoint (loading) of a unit
$R$	Regulating strength
$S(s)$	Sensitivity function
$s$	Laplace operator
$S_b$	Base power
$S_{n0}$	Scaled power base
$T_w$	Water time constant

# 1. INTRODUCTION

This chapter introduces the project, sets the framework and goals and gives the outline of the report.

## 1.1 BACKGROUND OF THE PROJECT

In July 2017 the project 'Revision of the Nordic Frequency Containment Process' (FCP-project) delivered its final reports. The report 'FCR-D Design of Requirements' [1] presents the developed methodology for design of new requirements for FCR-D and describes the new requirements. Those requirements were designed to keep the frequency above 49.0 Hz under some reasonable conditions in a system with a kinetic energy of 120 GWs. However, estimation of the total possible qualified hydropower capacity in Finland, Norway and Sweden showed that it is not possible to qualify enough capacity in Finland. One important assumption is that the units should be able to qualify at high loading i.e. 80 %. Therefore, phase 2 of the FCP project was initialised in order to increase the qualified capacity in Finland by relaxing the requirements. It should be mentioned that Sweden and Norway had no problem fulfilling their national procurement obligation with the requirements developed in phase 1. Since the design mainly studies hydropower and the fact that there is no hydropower in Denmark that delivers FCR, capacity estimation is not relevant in this context.

The design of requirements is based on a single machine system with a lumped mass model. The model only includes the study of active power and frequency whereas the impact from voltage is neglected. Therefore, to study how well such a simplified model can represent the dynamics in a more detailed modelled system this project also includes full-scale simulations of the Nordic PSS/E model, including all implemented dynamics.

The delivery of FCR-N and FCR-D is today mostly made by the same hydro units. Already today many hydro units are therefore equipped with a switch-over function in the governor when changing delivery from FCR-N to FCR-D and vice versa. The development of new FCR requirements will probably result in further increase of the switch-over function. To make sure that such a switch-over function does not harm the system behaviour this project includes studies of the switch-over.

## 1.2 FRAMEWORK FOR THE WORK

To meet the national obligations of qualified capacity in Finland relaxed requirements are to be developed. Note that in phase 1 the requirements were developed based on system needs of a 120 GWs kinetic energy system, but here the requirements will be based on qualifying sufficient capacity in Finland. Nevertheless, the requirements shall still fulfil system needs for stability and performance under the design conditions. In order to increase the qualified capacity, several options are available. The project was, after some discussion, limited to not use the same dimensioning kinetic energy for performance and stability. Stability was decided to be set for low kinetic energy whereas for performance it is allowed to apply high kinetic energy to qualify more capacity. The rationale behind this will be further explained in the report.

## 1.3 GOALS

This work aims at adjusting the FCR-D requirements developed in phase 1 of FCP-project. The new requirements shall, in addition to the previous requirements,

- Qualify sufficient capacity in Finland
- Set requirements for switch over between FCR-N and FCR-D

Furthermore, the requirements designed using simplified one bus model shall be verified using more complex multi machine models.

## 1.4 OUTLINE

Chapter 2 provides the development of the reviewed FCR-D requirements. This includes modification of stability and performance requirements to receive sufficient qualified capacity. In chapter 3 the possibility for units supplying both FCR-N and FCR-D via a parameter switch is evaluated. Also new requirements for units supplying both FCR services are included. To evaluate the simplified Matlab/Simulink model used when developing the FCR-D requirements comparative simulations have been performed with a full-scale PSS/E dynamic model. The results of these simulations are presented in chapter 4. Conclusions are drawn in chapter 5 and references can be found in chapter 6. Finally, Appendixes are listed in chapter 0.

## 2. REVISED REQUIREMENTS FOR FCR-D

The development of revised requirements is based on previous work published in [1] and readers are recommended to go through that document first.

### 2.1 FRAMEWORK

The FCR-D requirements that were developed in the FCP-project were designed to keep the frequency above 49.0 Hz after a sudden loss of 1450 MW of production in a system with a kinetic energy of 120 GWs. However, estimation of qualified hydro power capacity indicated that it is not possible to qualify enough hydro capacity in Finland with the designed requirements. In the capacity estimation it was assumed the units operate at 80 % loading.

In order to increase the qualified capacity in Finland, requirements have to be relaxed or it has to be assumed that units will decrease their loading when providing FCR-D. In fact, the loading has a significant impact on the possibility to qualify units. A lower loading may also qualify higher capacity in a unit. This comes from the fact that the effective water time<sup>1</sup> constant  $T_w$ , affecting the non-minimum phase dynamics and thereby the power change, varies with the loading of the unit.

However, it is assumed that the energy markets (day-ahead and intra-day) have a stronger influence on the operating point than the ancillary services markets [2]. Therefore, the operating point is not seen as a controllable variable for the design of FCR-D requirements, and in order to increase the qualified capacity the requirements have to be adjusted so that units are able to qualify sufficient capacity also at 80 % loading.

The target values for qualified capacity were defined by NAG and given as input to the project [2]. For Sweden and Norway the target is 150–200 % of the respective national obligation and for Finland 100 % of the Finnish obligation to be provided by the nations installed hydro power. The targets for Sweden and Norway can already be reached with the previously designed requirements and thus they do not become a constraint for the design of new requirements. Since the design mainly studies hydropower the capacity evaluation is not relevant for Denmark in this context, as there is no hydro power providing FCR there.

To summarize the design approach: in the FCP-project the qualified capacity was a result of the designed requirements which were purely based on system needs in a 120 GWs system. In this project the qualified hydro power capacity in Finland is fixed at 100 % of the national FCR-D obligation, and the requirements shall be relaxed so that this capacity constraint is satisfied. At the same time the system needs regarding stability and performance shall be fulfilled under the design conditions.

### 2.2 RELAXING THE REQUIREMENTS

Frequency stability from a broader perspective can be said to be affected by three main categories: reserves, kinetic energy in the system and the dimensioning incident. Since this project deals with reserves the two latter are considered as inputs rather than controllable. Thus, the dimensioning incident is kept at 1450 MW. Also the maximum allowed instantaneous frequency deviation is a

fixed constraint of 0.9 Hz (same as in the FCP-project [1]). However, the kinetic energy is viewed as an input variable as opposed to the FCP-project where it was a fixed constraint. Further, in the design of requirements the kinetic energy can be defined separately for the stability and the performance requirements.

Relaxing the stability and performance requirements can practically be done by changing the closed loop stability margin requirement or the dimensioning system kinetic energy. Assuming closed loop stability is prioritized, reducing the stability margin is not a feasible way to relax the requirements. Therefore, changing the kinetic energy is the better alternative.

The kinetic energy in the design of requirements can be changes in three different ways:

1. Let the design kinetic energy be the same for performance and closed loop stability

**Main point:** Design kinetic energy for performance is the kinetic energy in the system for which the FCR-D keeps the frequency above 49.0 Hz for the dimensioning incident.

Design kinetic energy for stability is the kinetic energy in the system for which FCR-D ensures the close loop stability margin.

requirement ( $E_{kp} = E_{ks}$ )

2. Let the design kinetic energy be larger for performance than closed loop stability requirement ( $E_{kp} > E_{ks}$ )
3. Let the design kinetic energy be smaller for performance than closed loop stability requirement ( $E_{kp} < E_{ks}$ )

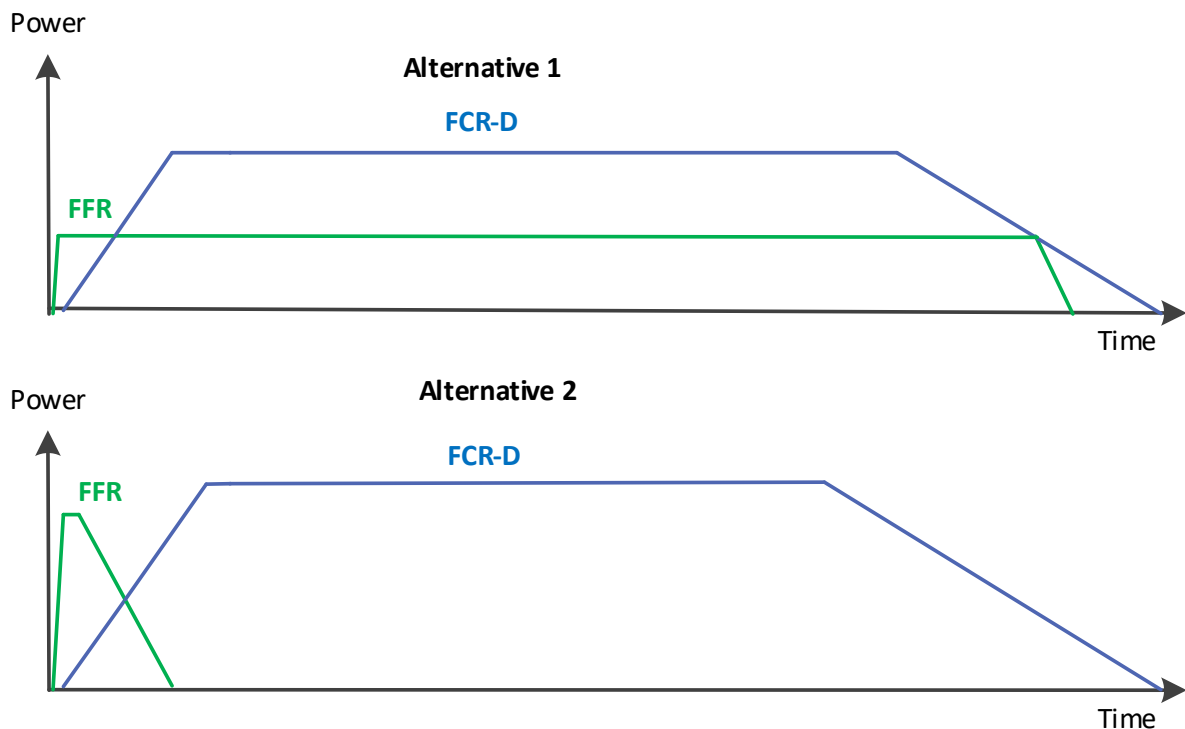
If closed loop stability is prioritised, reducing the stability margin is not a feasible way to relax the requirements. Therefore, changing the kinetic energy is the better alternative. However, only the first two options for changing the kinetic energy make sense if closed loop stability is prioritised and this can be explained as follows: The pre-qualified reserves will be able to keep the frequency above 49.0 Hz if the system kinetic energy is larger or equal to the design kinetic energy for performance. However, if the actual kinetic energy is smaller than the design kinetic energy for stability, the closed loop stability margin is smaller than the stability margin requirement that was set. Then the closed loop stability margin suffers, hence, the third alternative is not appealing as sufficient stability margin has to be guaranteed.

Looking closer to the second alternative a corresponding rationale can be described. If the system kinetic energy is smaller than the design kinetic energy for performance the instantaneous frequency minimum may not be kept above 49.0 Hz for the dimensioning incident. However, if the system kinetic energy is still above the design kinetic energy for closed loop stability the system can be assumed to remain closed loop stable. This also means that another reserve, fast frequency reserve (FFR), is needed to cover up for lack of performance if the system kinetic energy is smaller than what performance is designed for. Such an FFR would only need to inject a short power boost, e.g. 10-20 seconds and will not necessarily affect the closed loop stability.

In the case of applying the first alternative the FFR has to be able to sustain until frequency replacement restoration reserve (FRR) is activated. If the system kinetic energy is lower than the



designed kinetic energy ( $E_k < E_{ks} = E_{kp}$ ) the regulating strength would need to be reduced in order to keep the closed loop stability margin. By doing so, the performance is also reduced and FCR-D is no longer able to keep the instantaneous frequency deviation within limits in the event of the dimensioning incident. Thus, the faster reserve, FFR, would need to cover up for lack of performance meanwhile replacing the reduced volume of FCR-D. In Alternative 1, the stability requirement is relaxed for FCR-D as a countermeasure at lower kinetic energy is to replace FCR-D with FFR. By replacing FCR-D in such situations the stability margin is assumed to remain due to more stable design of FFR. Alternatives 1 and 2 imply different frameworks for FFR, illustrated in Figure 1.



**FIGURE 1. ILLUSTRATION OF FFR PROPERTIES FOR ALTERNATIVE 1 AND 2.**

Pros and cons have been listed in order to select one of the options and a decision has been taken based on these qualitative properties. In this FCP-2 project a thorough investigation has not been performed in order to find the better option in terms of for example pre-qualified capacity, possible technologies to deliver FFR etc. as it is out of the scope of this project. Alternative 2 was chosen, i.e., closed loop stability should be designed for a low inertia system so that the kinetic energy rarely goes below this value. Kinetic energy for performance will then be adjusted in order to pre-qualify more capacity. Note that the loading level of units delivering FCR-D also is a parameter that can be changed. In Figure 2, the methodology is displayed in a flowchart which illustrates the different steps and considerations made in order to increase the pre-qualified capacity. In all, the kinetic energy for performance is the designed value where FCR-D alone can handle the dimensioning incident without support from FFR. Figure 2 shows an overview of the process to achieve the goal of finding more qualified capacity. It simply starts with setting up the frame work and the varying the design kinetic energy for performance and to some extent also for close loop stability.

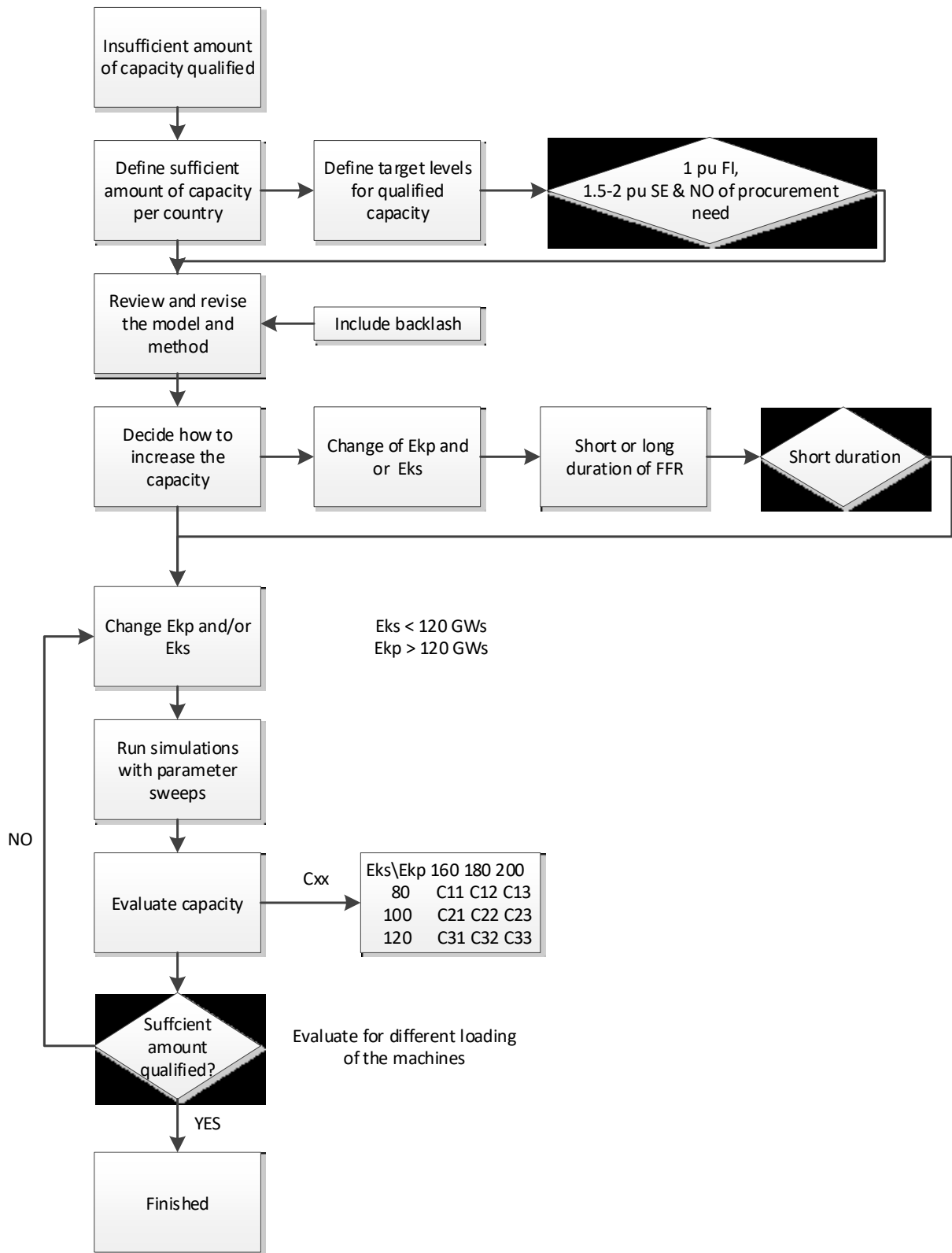


FIGURE 2. ILLUSTRATIVE FLOW-CHART OF THE PROCESS TO MEET THE CAPACITY REQUEST IN FINLAND.

## 2.3 CAPACITY EVALUATION

One of the constraints described in Section 2.1 is to qualify the amount of capacity needed for each country, which was decided by NAG. This subsection describes the method developed for estimating the qualified capacities in respective countries.

### 2.3.1 INSTALLED CAPACITY

The data for FCR providing units in the Nordic is based on the survey [3]. There it is assumed that all hydro units with a rated power > 10 MVA can supply FCR-D. This sums up to an installed capacity of approximately 45 GW in the Nordic system. The survey cover a portion of the units in the Nordic system, but not all of them. It is, however, assumed that the achieved distribution between  $T_w$  and installed capacity is representative for the complete system, i.e. the distribution between  $T_w$  and capacity has been up scaled to the total Nordic system installed hydro power capacity. For this actual study, additional data for Finnish units has been added which means that there is data available on almost all Finnish hydro units [4]. Table 1 and Figure 3 shows the capacity distributed by water time constant. Note that capacity with water time constant higher than 2.2 seconds are not included. Simulations performed show that such units are not able to qualify, e.g. in Figure 4 where no capacity is qualified for units with  $T_w$  over 1.8 s, even at the highest inertia level evaluated in Section 2.3.3. The challenge is to use the known information to find how much expected FCR-capacity there is in the system, i.e. using the water time constant and the respective installed capacity to find the ability to qualify FCR capacity.

TABLE 1: INSTALLED HYDRO CAPACITY IN THE NORDIC POWER SYSTEM DISTRIBUTED BY COUNTRY AND WATER TIME CONSTANT

Water time constant, $T_w$ [s]	Norway [MW]	Sweden [MW]	Finland [MW]
<=1.2	21429	7612	742.2
1.21-1.4	4204	2146	129.2
1.41-1.6	2347	1909	353.6
1.61-1.8	0	1275	49.3
1.81-2.0	0	1758	679.6
2.01-2.2	0	0	56.3

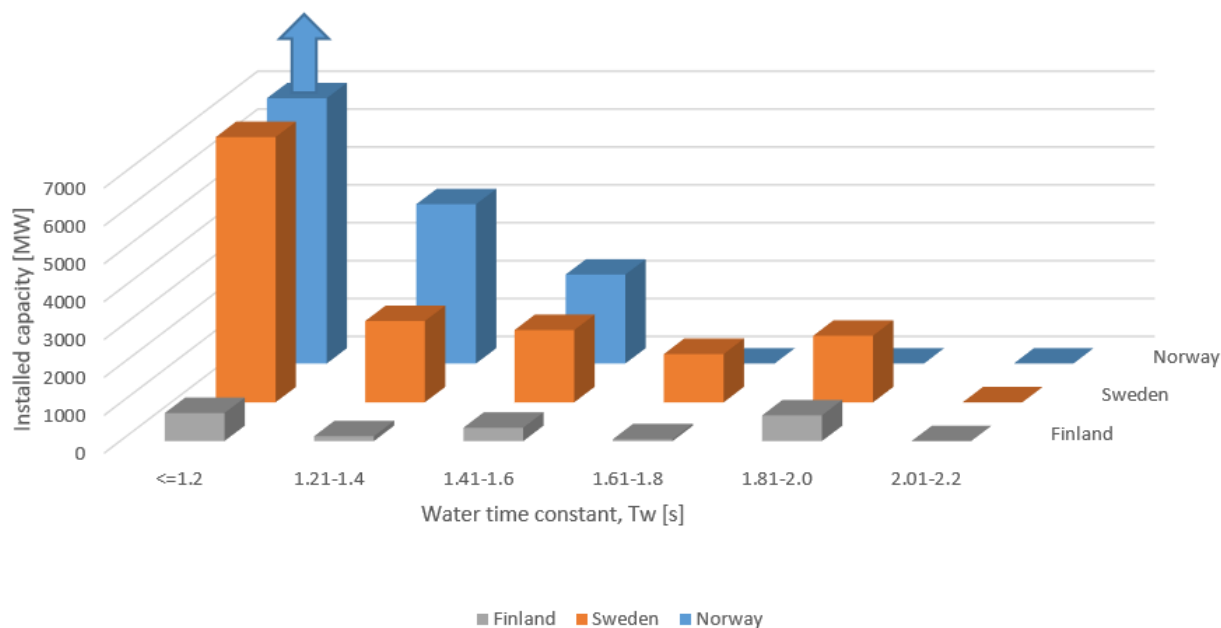


FIGURE 3: INSTALLED HYDRO CAPACITY IN THE NORDIC POWER SYSTEM DISTRIBUTED BY COUNTRY AND WATER TIME CONSTANT

### 2.3.2 SIMULATION RESULTS

The simulation model derived in the FCP-project [1] are used to estimate how much capacity any given design for FCR-D requirement gives, by relating the results to the data for the installed capacity. The simulation model uses the dimensioning criteria and a number of parameter sets, and returns a stability margin ( $M_s$ ) and a capacity ( $C_{FCR}$ ) for each parameter set. The stability requirement (stability margin,  $M_s > M_{s,req}$ ) must be fulfilled, otherwise the capacity is considered to be zero.

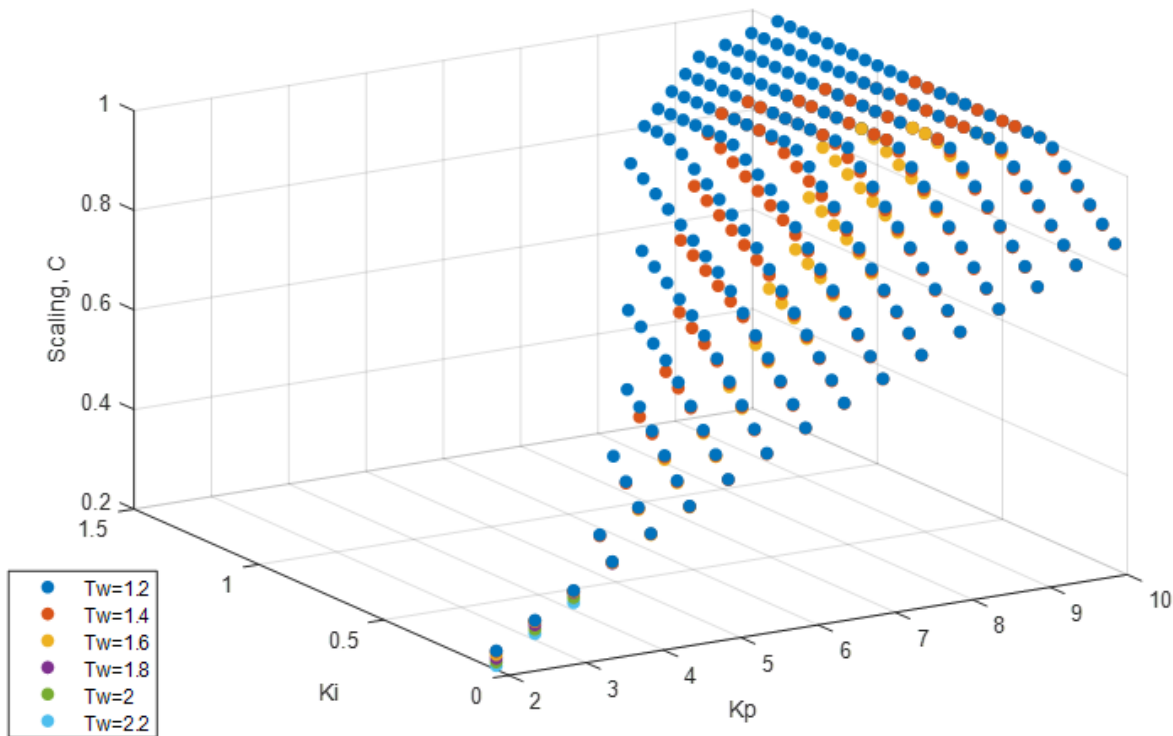
The challenge is to find the simulation results most representative for each water time constant. The parameters are dependent on either tuning of the governor, mechanical properties or loading of the unit.

### 2.3.3 APPROACH

The goal of the method is to estimate how much capacity that can be expected in the market from the current installed hydro capacity. Using the word "expect" is not coincidental, because even though the installed capacity and the respective properties are fairly well known, the estimation has to take into account some non-technical limitations as well. Especially the ability/probability to find the optimal tuning of the units. Every production unit will have a PID parameter set that gives the highest capacity, but it may not be straight forward to find it. This should be taken into account when deriving the method.

Using all constraints described in Subsection 2.1 and the simulation results, there are three unknown variables – droop, proportional gain and integral gain. By plotting these the results of the simulations can be observed visually. To see all the results, one plot for each droop setting must be made Figure

4 shows how different units, characterized by  $T_w$ , achieve a capacity at different combinations of proportional and integral gain at 4% droop. The capacity is given as a share of the stationary capacity (between 0 and 1). Note that all parameter sets that do not qualify for stability are excluded. For this particular plot, it can be observed that combinations of low proportional gain and high integral gain does not qualify (left part of the figure). For the qualified sets however, the trend is that higher proportional gain allows higher integral gain while still ensuring stability, and simultaneously giving a higher capacity.



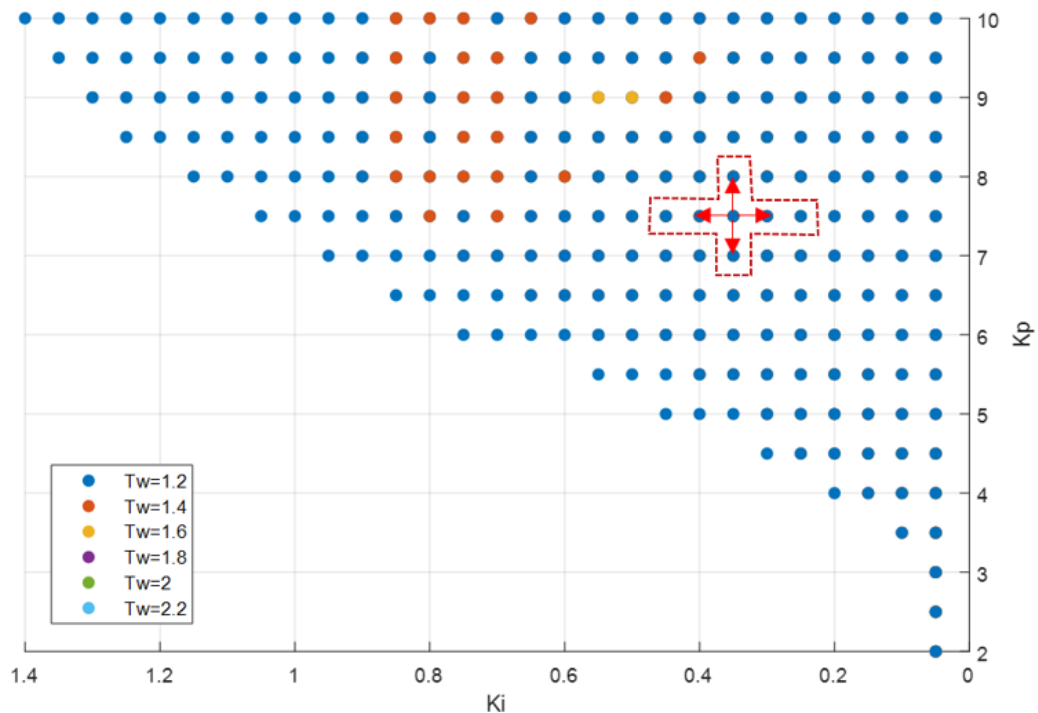
**FIGURE 4: 3D-PLOT OF CAPACITY PLOTTED AS A FUNCTION OF PROPORTIONAL GAIN,  $K_p$ , AND INTEGRAL GAIN,  $K_i$ , FOR DIFFERENT WATER TIME CONSTANTS,  $T_w$  (SEE LEGEND). EKS=90 GWS, EKP=300 GWS, BACKLASH=0.5% AND DROOP AT 4%.**

The optimization should search for the optimal parameter set (by this point reduced to a combination of droop, proportional gain and integral gain) is done in the following way;

- Each  $T_w$  is evaluated at all droops to find the highest capacity. Since the performance and stability is dependent of droop, increasing droop may still give higher qualified capacity even though the steady state power response is lower. This will be visible in the simulations as capacity scaling. E.g. the capacity scaling at 8% droop is more than double the capacity scaling at 4% droop, resulting in higher droop.
- The optimal combination of proportional and integral gain with regard to capacity scaling should be found for all  $T_w$  and droop combinations. However, the approach for finding the optimal capacity scaling should take into account the potential difficulty in finding it.

To simplify the approach for finding the representative capacity scaling for each combination of  $T_w$  and droop, it is easier to view Figure 4 in two dimensions, see Figure 5. In order to represent the uncertainty in finding the optimal parameter set, it is decided to use the average of a neighbouring parameter sets. The red outlining in Figure 5 illustrates the meaning of neighbouring parameter sets. For each combination of proportional and integral gain, the average of itself and the 6

surrounding combinations are calculated. If any of the points are empty, that is if a neighbouring point is either non-qualified for stability or outside the evaluated ranges of proportional or integral gain, then the capacity is set to zero. Both using the average of multiple parameter sets and disqualification of the extremes (close to instability or evaluation range) can be regarded as ways to express the uncertainty in finding the optimal parameters.



**FIGURE 5: QUALIFIED PARAMETER SETS AS A FUNCTION OF PROPORTIONAL GAIN,  $K_p$ , AND INTEGRAL GAIN,  $K_i$ , FOR DIFFERENT WATER TIME CONSTANTS,  $T_w$  (SEE LEGEND). 2D-VISUALISATION OF FIGURE 4. EKS=90 GWS, EKP=300 GWS, BACKLASH=0.5% AND DROOP AT 4%.**

The decided method for finding the representative capacity for each combination of  $T_w$  and droop is implemented in an optimization script. The script does the following to optimise the FCR capacity for each  $T_w$ .

1. From the simulation results
  - a. Reducing the number of parameter sets according to the simplifications (derivative gain equal to zero, loading 80 % and backlash equal to 1%)
2. For all different  $T_w$ 's:
  - a. For all the different droop settings;
    - i. Calculate the steady state activation from droop and installed capacity in each country
      1. For all different combinations of proportional and integral gain
        - a. Check the stability requirement
        - b. If the stability requirement is fulfilled
          - i. Find the average capacity scaling using the "average of a square" or the "average of a cross"

- ii. Multiply the steady state activation with the average capacity scaling to find the FCR capacity
  - iii. If the FCR capacity is higher than the previous results, save as new optimal along with the droop setting
3. Summarize all capacity results in a table per country and  $T_w$

An example of the results of calculating capacity is given in Table 2. The requirements and simulation results are for a system designed with inertia level for stability at 90 GWs and an inertia level for performance at 300 GWs with backlash of 0.5 %.

**TABLE 2: EXAMPLE OF ESTIMATED FCR-D CAPACITY FROM UNITS IN THE NORDIC POWER SYSTEM BY WATER TIME CONSTANT, USING  $E_{ks} = 90 \text{ GWs}$ ,  $E_{kp} = 300 \text{ GWs}$  AND BACKLASH OF 0.5 %.**

Water time constant, $T_w$ [s]	Qualified FCR-D capacity at optimal droop					
	Norway [MW]	@ droop	Sweden [MW]	@ droop	Finland [MW]	@ droop
<b>&lt;=1.2</b>	4282.04	0.04	1521.06	0.04	148.31	0.04
<b>1.21-1.4</b>	838.55	0.04	428.05	0.04	25.77	0.04
<b>1.41-1.6</b>	457.58	0.04	372.19	0.04	68.94	0.04
<b>1.61-1.8</b>	0.00	-	92.39	0.08	3.57	0.08
<b>1.81-2.0</b>	0.00	-	0.00	-	0.00	-
<b>2.01-2.2</b>	0.00	-	0.00	-	0.00	-
<b>Sum</b>	<b>5578.17</b>		<b>2413.70</b>		<b>246.59</b>	

## 2.4 FINDING THE PERFORMANCE REQUIREMENTS AT DIFFERENT LEVELS OF KINETIC ENERGY

Finding a performance requirement is an iterative process where the kinetic energy is increased in steps until the capacity target is met. It shall be noted that the stability requirement is not affected; the kinetic energy is changed for the performance requirement only. The stability requirement is dimensioned for a 90 GWs system.

The simulation parameters are varied and in total 163 200 combinations are simulated. The ranges of the parameters are presented in Table 3. To simplify the calculations and to reduce computing time, the derivative gain of the controller ( $K_d$ ) is set to zero. Typically, qualified capacity increases if  $K_d$  is set to a higher value. For finding the performance requirement the backlash of the hydro units is set to zero. Backlash does not have an impact on finding the performance requirement because the requirement is based on system needs. However, a non-zero value is used in the capacity evaluation. FCR-D capacity is set to 1450 MW. The simulations are performed for two values of regulating strength: 4500 MW/Hz and 3625 MW/Hz.

TABLE 3 SIMULATED PARAMETER VARIATIONS FOR PERFORMANCE REQUIREMENT

Parameter	Range
$K_p$	2-10
$K_i^2$	0.05-5 [ $s^{-1}$ ]
$K_d$	0
$e_p$	2-8 [%]
$T_w$	1.2-2.2 [s]
$P_{set}$	40-80 [%]
BL	0 [ $\rho u$ ]

The simulations include open and closed loop simulations with the same parameter sets. The open loop test signal is a ramp from 49.9 to 49.0 Hz. The ramp represents the rate of change of frequency (RoCof) in case the dimensioning fault would occur in the system. Hence, the RoCof of the open loop frequency signal depends on the system kinetic energy. For each simulated value of the kinetic energy the RoCof of the test signal is calculated as

$$\frac{df}{dt} = \frac{\Delta P_{\text{disturbance}} \cdot f_0}{2 \cdot E_{kp}} \text{ [Hz/s]} \quad (2.1)$$

where  $f_0$  is the nominal frequency (50 Hz),  $\Delta P_{\text{disturbance}}$  is the dimensioning disturbance (-1450 MW) and  $E_{kp}$  is the kinetic energy in the system.

<sup>2</sup>  $K_i$  is scaled with droop to keep the integrating time constant the same for a specific  $K_i$



In the closed loop the dimensioning disturbance, a loss of 1450 MW of power, is simulated. The initial frequency is the same as in the open loop simulations, 49.9 Hz. The closed loop frequency is used to assess which parameter sets deliver acceptable performance, i.e. the frequency nadir is 49.0 Hz or higher.

The open and closed loop simulation results are used to find a performance requirement in the open loop that represents the desired closed loop performance as well as possible. Based on the analysis presented in [1], it is decided that the performance requirement shall consist of two requirements: one for power and one for energy. Further, the power requirement shall be 0.93 pu in order to ensure the needed amount of FCR-D is activated. The remaining 7 % of the required power comes from frequency dependent loads in a low load system. When the requirement is dimensioned for a higher kinetic energy, it is likely that also the system load will be higher. Thus, more power may be provided by frequency dependent loads. However, the impact is difficult to estimate and therefore a power requirement of 0.93 pu is used for all kinetic energies.

The time for the requirement on power and energy is varied in steps of 1 second. Time is defined from the start of the open loop ramp. The value of the required energy is varied in steps of 0.1 pu·s. The range of values for time and energy are adjusted based on the kinetic energy. When the kinetic energy is increased, the ramp becomes slower and the most suitable requirement is found at a later time. At a later time also the amount of energy supplied to the system becomes higher.

To assess how good a tested requirement is at qualifying units with good performance and at disqualifying units with insufficient performance, three key performance indicators are calculated. The indicators are KPI 1, KPI 2 and KPI 3 as defined in [1]:

- KPI 1: The share of units that qualify according to the requirement and keep  $f_{\min} > 49.0$  Hz of all units keeping  $f_{\min} > 49.0$  Hz [%]
- KPI 2: The share of units that qualify according to the requirement and do not keep  $f_{\min} > 49.0$  Hz of all units not keeping  $f_{\min} > 49.0$  Hz [%]
- KPI 3: KPI 1 and KPI 2 combined, that is  $KPI3 = 100 - KPI1 + KPI2$

When selecting the performance requirements, it is considered beneficial to have the same time for both of the requirements as it simplifies the requirements. The requirement combination with the same time and with the best (lowest) KPI 3 is chosen for each simulated kinetic energy. The chosen requirements are presented in Table 4 for a regulating strength of 4500 MW/Hz and in Table 5 for 3625 MW/Hz.

**TABLE 4 PERFORMANCE REQUIREMENTS FOR A REGULATING STRENGTH OF 4500 MW/Hz**

Kinetic energy (GWs)	Requirement			KPIs		
	Time (s)	Power (pu)	Energy (pu·s)	KPI 1 (%)	KPI 2 (%)	KPI 3 (%)
100	4	0.93	1.3	97.85	1.00	3.15
120	5	0.93	1.8	98.14	1.13	2.99
140	7	0.93	3.4	98.33	0.72	2.39
160	8	0.93	3.9	98.64	0.65	2.01
180	9	0.93	4.4	99.05	0.76	1.71
200	10	0.93	4.9	99.03	0.88	1.84
220	11	0.93	5.4	99.08	1.07	1.83
240	12	0.93	6.0	98.33	0.16	1.83
260	13	0.93	6.5	98.51	0.22	1.72
280	15	0.93	8.1	98.82	0.31	1.49
300	16	0.93	8.6	98.94	0.35	1.41

**TABLE 5 PERFORMANCE REQUIREMENTS FOR A REGULATING STRENGTH OF 3625 MW/Hz**

Kinetic energy (GWs)	Requirement			KPIs		
	Time (s)	Power (pu)	Energy (pu*s)	KPI 1 (%)	KPI 2 (%)	KPI 3 (%)
100	5	0.93	2.3	99.87	1.87	2.00
120	6	0.93	2.8	99.41	2.96	3.56
140	7	0.93	3.3	99.31	3.10	3.79
160	8	0.93	3.9	97.45	0.64	3.19
180	9	0.93	4.4	98.22	0.67	2.45
200	10	0.93	4.9	98.41	0.77	2.36
220	11	0.93	5.4	98.64	0.92	2.27
240	13	0.93	7.0	98.74	0.91	2.17
260	14	0.93	7.5	98.95	0.97	2.02
280	15	0.93	8.0	98.99	1.02	2.03
300	16	0.93	8.6	98.44	0.22	1.78

By comparing the results in Table 4 and Table 5 it can be concluded that the regulating strength does not have a significant impact when choosing the performance requirement. This is an expected result as the requirement relates to the dynamical response that the system needs in order to withstand the dimensioning fault. In many of the simulated cases exactly the same requirement is chosen based on the smallest KPI 3, though the value of KPI 3 differs. In a couple of cases the chosen requirement is slightly different. However, even in these cases it could be accepted to use the requirements for 4500 MW/Hz, presented in Table 4, for 3625 MW/Hz as well because they still have good KPI values.

## 2.5 QUALIFIED FCR-D CAPACITY PER COUNTRY

This section presents the results achieved from simulations assessing qualified capacity. Simulations have been run with the parameters shown in Table 3. However, backlash has been included and set to 0.5 % and 1 % based on rated power of the machine, Figure 6 shows where backlash has been included. Capacity is evaluated as described above and the kinetic energy is varied for the close loop stability and the performance requirement. The capacity is evaluated for two different loading levels. A lower loading will significantly increase the qualified capacity, explained below.

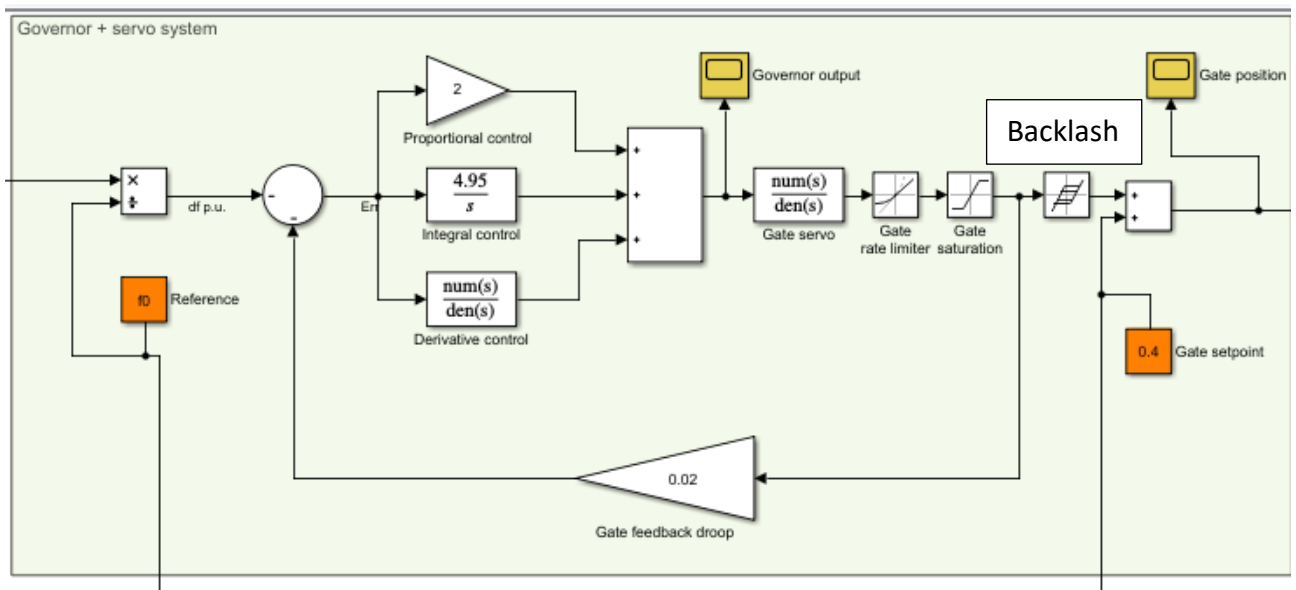
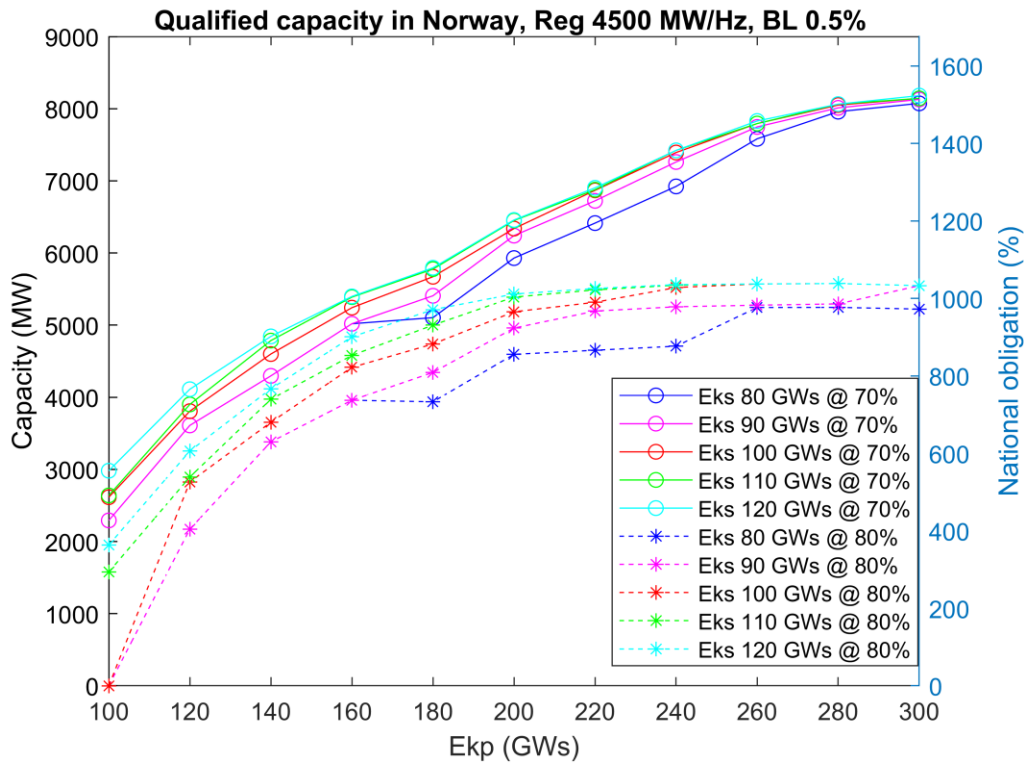


FIGURE 6. BLOCK DIAGRAM OF THE GOVERNOR AND SERVO.

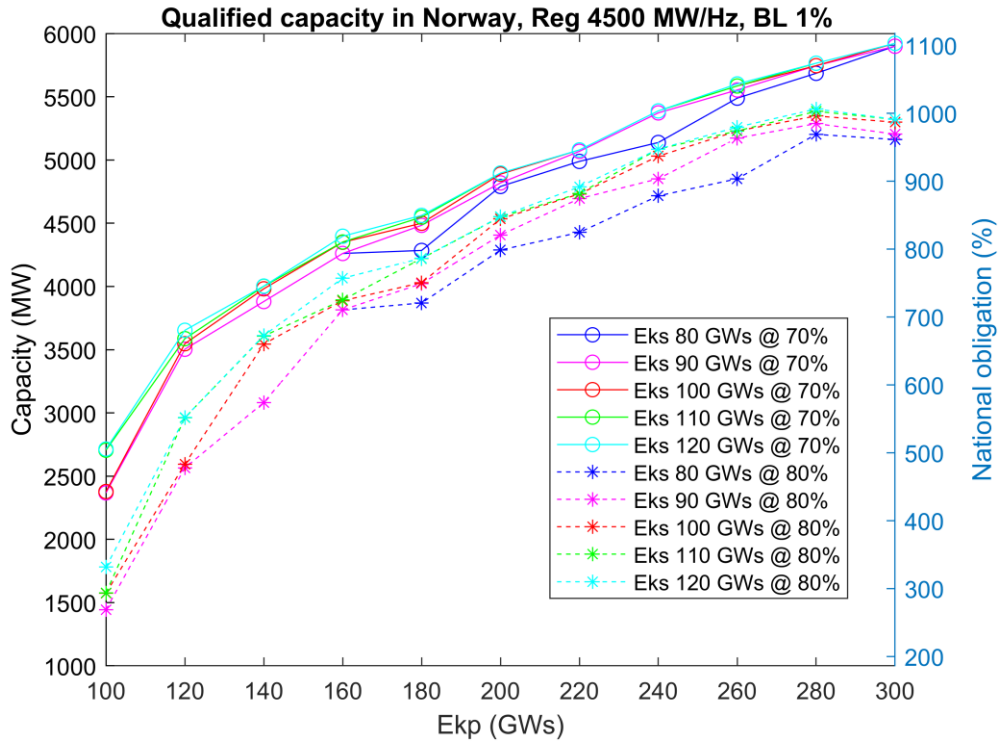
### 2.5.1 NORWAY

Norway has quite a lot of installed hydro power and comparatively low water time constants, ranging from 1.2 to 1.6 seconds. Figure 7 and Figure 8 show the result, as can be seen already at low values of kinetic energy for performance and stability ( $E_{kp}$  around 100 GWs) the national obligation is reached. However, there is a bit of uncertainty as none of the parameter combinations qualify for very low kinetic energy with 0.5 % backlash while there are combinations with 1 % backlash that qualify. The estimation ends up with a larger value at a smaller backlash but at a very low kinetic energy there are situations where a larger backlash is beneficial. This can be explained by the fact

that a larger backlash reduces the already small output at shorter time periods where the phase shift is rather large and thereby makes it easier to comply with the stability requirement.



**FIGURE 7. ESTIMATED CAPACITY IN NORWAY BASED ON INSTALLED CAPACITY AND DISTRIBUTION OF WATER TIME CONSTANTS. LEFT Y-AXIS IS IN MW AND TO THE RIGHT IN PERCENTAGE OF NATIONAL OBLIGATION (537 MW [FCR MARKET LIQUIDITY NEEDS]). BACKLASH IS SET TO 0.5 % OF RATED MACHINE POWER. EVALUATED FOR LOADING OF 70 % AND 80 %.**



**FIGURE 8. ESTIMATED CAPACITY IN NORWAY BASED ON INSTALLED CAPACITY AND DISTRIBUTION OF WATER TIME CONSTANTS. LEFT Y-AXIS IS IN MW AND TO THE RIGHT IN PERCENTAGE OF NATIONAL OBLIGATION (537 MW [FCR MARKET LIQUIDITY NEEDS]). BACKLASH IS SET TO 1 % OF RATED MACHINE POWER. EVALUATED FOR LOADING OF 70 % AND 80 %.**

### 2.5.2 SWEDEN

Sweden has also a significant amount of hydro power, roughly half of the installed capacity in Norway. On average the water time constant is slightly higher than in Norway ranging from 1.2 to 2.0 seconds. The results are shown in Figure 9 and Figure 10 and similar to Norway the national obligation is met at a rather low kinetic energy. Also here a difference can be observed between the two different backlash values and generally smaller backlash is better but there are some exceptions. The national obligation is reached at a rather small kinetic energy and according to this estimation the requirements from the previous project phase ( $E_{ks}=E_{kp}=120$  GWs) would result in >150-200 % of the national obligation.

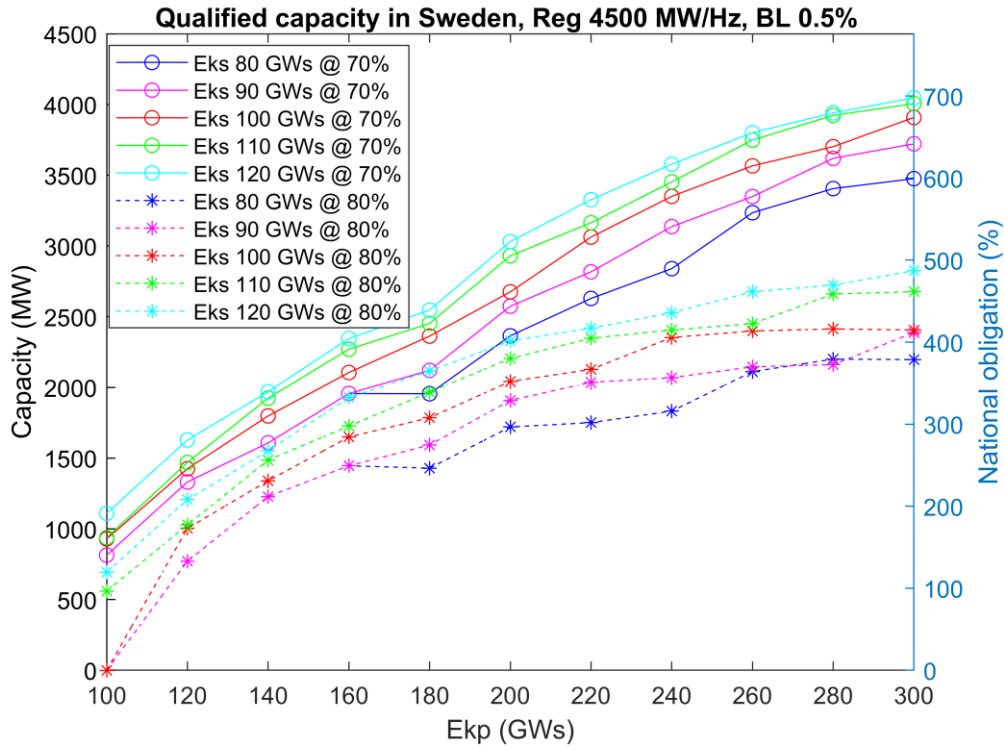


FIGURE 9. ESTIMATED CAPACITY IN SWEDEN BASED ON INSTALLED CAPACITY AND DISTRIBUTION OF WATER TIME CONSTANTS. LEFT Y-AXIS IS IN MW AND TO THE RIGHT IN PERCENTAGE OF NATIONAL OBLIGATION (580 MW [FCR MARKET LIQUIDITY NEEDS]). BACKLASH IS SET TO 0.5 % OF RATED MACHINE POWER. EVALUATED FOR LOADING OF 70 % AND 80 %.

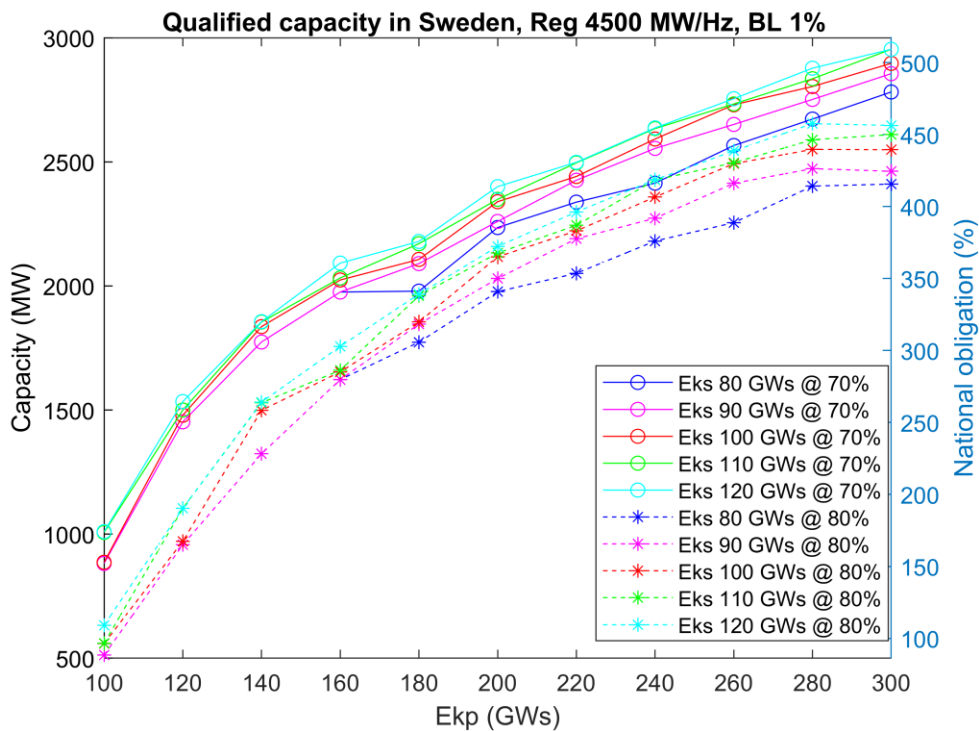


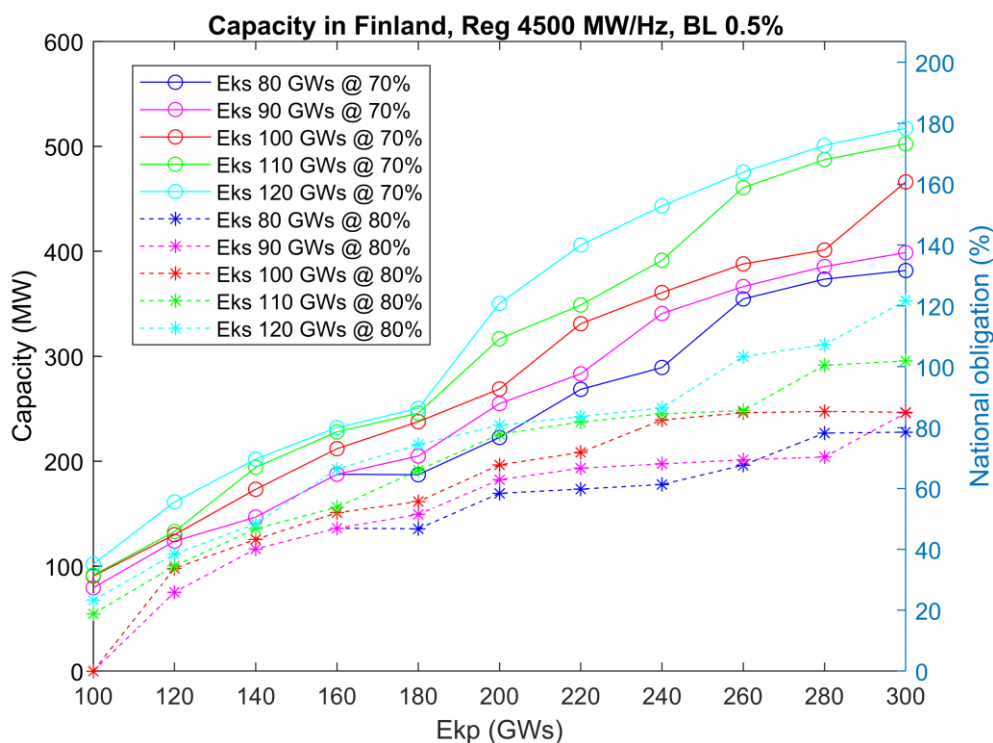
FIGURE 10. ESTIMATED CAPACITY IN SWEDEN BASED ON INSTALLED CAPACITY AND DISTRIBUTION OF WATER TIME CONSTANTS. LEFT Y-AXIS IS IN MW AND TO THE RIGHT IN PERCENTAGE OF NATIONAL OBLIGATION (580 MW [FCR MARKET LIQUIDITY NEEDS]). BACKLASH IS SET TO 1 % OF RATED MACHINE POWER. EVALUATED FOR LOADING OF 70 % AND 80 %.

### 2.5.3 FINLAND

A driving force during the project has been to meet the Finnish obligation of FCR-D provided by hydro power. The conditions are not easy as the installed hydro capacity in Finland is rather limited. In fact, at 80 % loading the headroom is only 400 MW. It is also worth mentioning that FCR-N should be provided on top of FCR-D and the obligation of the total amount of FCR for Finland is larger than 400 MW.

Another important aspect when qualifying the Finnish units is that the water time constants of the units ranges from 1.2 to 2.2 seconds with most of the installed power at 1.2 seconds and 2.0 seconds.

The result of the qualified capacity in Finland is shown in Figure 11 and Figure 12, clearly a large value of the kinetic energy for performance is required to meet the obligation in Finland. An alternative is to reduce the loading, however, this might have a negative impact on the energy market as the production then needs to be limited. In all, the kinetic energy for performance has to be increased to 300 GWs in order to meet the national obligation of Finland.



**FIGURE 11. ESTIMATED CAPACITY IN FINLAND BASED ON INSTALLED CAPACITY AND DISTRIBUTION OF WATER TIME CONSTANTS. LEFT Y-AXIS IS IN MW AND TO THE RIGHT IN PERCENTAGE OF NATIONAL OBLIGATION (290 MW [FCR MARKET LIQUIDITY NEEDS]). BACKLASH IS SET TO 0.5 % OF RATED MACHINE POWER.**

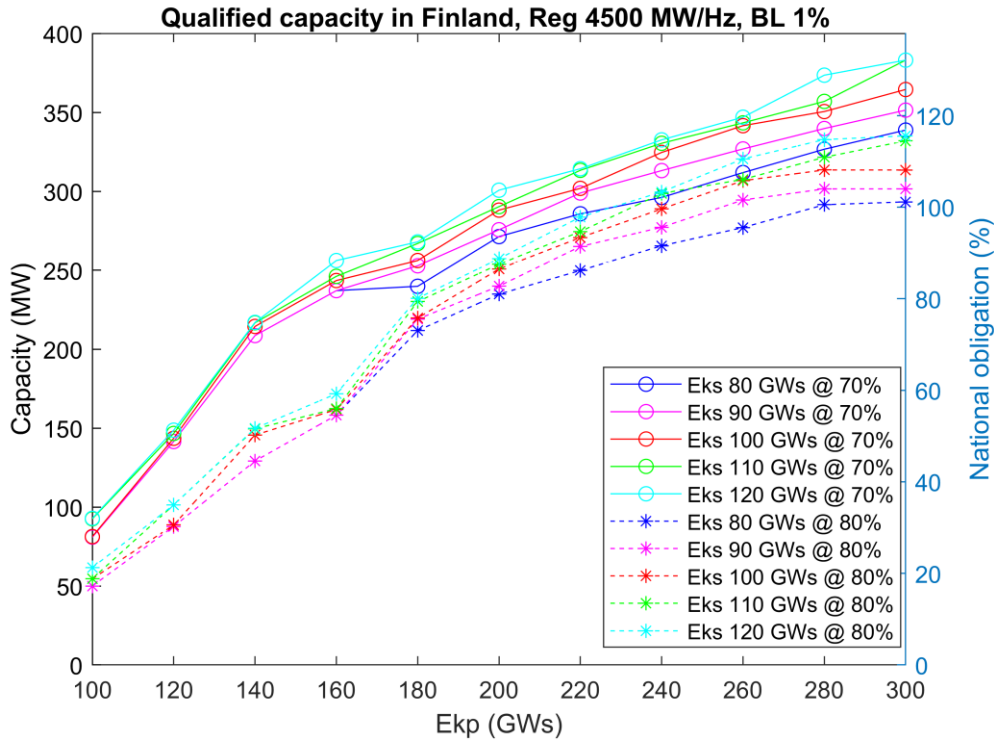


FIGURE 12. ESTIMATED CAPACITY IN FINLAND BASED ON INSTALLED CAPACITY AND DISTRIBUTION OF WATER TIME CONSTANTS. LEFT Y-AXIS IS IN MW AND TO THE RIGHT IN PERCENTAGE OF NATIONAL OBLIGATION (290 MW [FCR MARKET LIQUIDITY NEEDS]). BACKLASH IS SET TO 1 % OF RATED MACHINE POWER.

## 2.6 CLOSED LOOP STABILITY

### 2.6.1 STABILITY REQUIREMENT AND REGULATING STRENGTH

In the previous project the stability requirement was based on the same requirement as for FCR-N regarding system kinetic energy (120 GWs) and stability margin. However, a difference was the regulating strength which was 6000 MW/Hz and 3625 MW/Hz for FCR-N and FCR-D, respectively. The regulating strength impacts the parameter sets that qualify but not necessarily the performance. Using the same kinetic energy for stability but different regulating strength will not give a large overlap, if any, between qualified parameters for FCR-N and FCR-D. However, this overlap can be enlarged by adjustment of the regulating strength. An overview of the system considered here is shown in Figure 13.

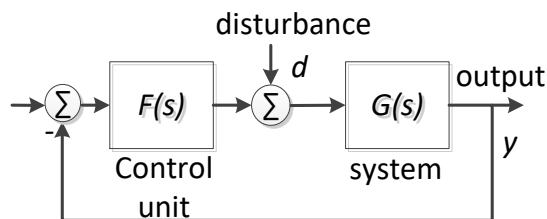


FIGURE 13: OVERVIEW OF A FEEDBACK SYSTEM

Looking closer to the stability equation, the loop transfer function looks as follows [1]



$$L(s) = F(s)G(s) = RF_0(s)G(s). \quad (2.2)$$

The sensitivity function is defined as

$$S(s) = \frac{1}{1+L(s)}. \quad (2.3)$$

Under the assumption of zero frequency dependency (2.2) can be written as

$$L(s) = \frac{RF_0(s)}{\frac{2E_{ks}s}{f_0}} = \frac{R}{E_{ks}} \left[ \frac{F_0(s)}{\frac{2s}{f_0}} \right]. \quad (2.4)$$

Clearly, the ratio between regulating strength and kinetic energy (inertia constant) plays an important role. For the same ratio between the regulating strength and the inertia constant (kinetic energy) the closed loop stability remains. As an example, in a system with kinetic energy for closed loop stability equal to 90 GWs a corresponding regulating strength of 4500 MW/Hz ends up with the same sensitivity function as FCR-N, hence, the same stability margin for the FCR response. This is calculated as

$$\frac{R}{E} = \frac{6000 \frac{MW}{Hz}}{120 \text{ GWs}} = \frac{4500 \frac{MW}{Hz}}{90 \text{ GWs}}. \quad (2.5)$$

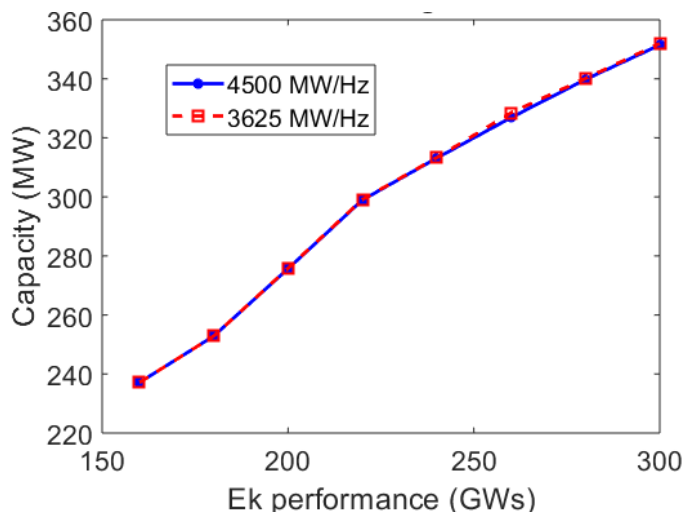
In the case of non-zero frequency dependency, to have the exact same close loop stability, the effect from the frequency dependency must scale linearly with change in kinetic energy. This can be thought as a system with reduced inertia is more likely to accommodate less load. Otherwise the expression will be an approximation.

To conclude, given a kinetic energy for closed loop stability the corresponding regulating strength can be calculated, using (2.5), so that the stability criterion is then the same for FCR-D and FCR-N. Assuming a performance scaling factor of one, a unit that qualifies for closed loop stability in the FCR-N test will automatically be qualified for stability in FCR-D with the same settings.

**Main point:** With a remaining ratio between regulating strength and kinetic energy close loop stability remains.

Dynamic response is the other side of the coin as it is strongly correlated with the regulating strength. When using the same governor parameters, changing the regulating strength changes the dynamic performance. For example, reducing the regulating strength reduces the performance. On the other hand it allows room for a more aggressive parameter setting (as the stability margin increases). In general, the maximum dynamic performance remains constant as the governor parameters can be changed accordingly. Figure 14 shows that there are other PID parameters that will result in the same qualified capacity for various regulating strength. Hence the maximum

dynamic performance is not affected by the regulating strength. The regulating strength states the stationary frequency level at which the power balance occurs.



**FIGURE 14. PRE-QUALIFIED CAPACITY IN FINLAND FOR TWO DIFFERENT SYSTEM REGULATING STRENGTHS. A BACKLASH OF 1 % AND UNIT LOADING OF 70 % ARE USED IN A SYSTEM WITH A KINETIC ENERGY OF 90 GWs.**

**Main point:** The maximum dynamic capacity remains at various regulating strengths under the same conditions.

## 2.6.2 SENSITIVITY ANALYSIS OF THE STABILITY REQUIREMENT

The design of the requirements in this project considers a stability margin expressed as a circle in the Nyquist plane (maximum sensitivity of 2.31) with a radius of 0.43. Stability is generally assessed before activation of the FCR-D reserve. This is a non-conservative approach as stability also must be maintained when FCR-D is activated. Therefore, it is also relevant to assess stability after activation. Mainly the effective water time constant is changed (increased) as FCR-D is activated. Other changes, such as incremental gain<sup>3</sup> due to non-linear relation between the gate opening and power output is not modelled here.

Figure 15 shows the sensitivity using qualified parameters for 120 GWs of stability assessed for a system with 90 GWs. The dashed line marks the requirement: parameter combinations that give a sensitivity above this line have a smaller stability margin than required. Clearly the stability margin is reduced if the stability requirement is designed for 120 GWs but the actual kinetic energy in the system decreases to 90 GWs. In the worst case it is reduced by 32 %. In the figure also the large

<sup>3</sup> For units using guide vane feedback our test results show two different impacts  
Pelton and Francis: MW/Hz decrease with the loading of the unit  
Kaplan: MW/Hz increase with the loading of the unit

impact of the loading before and after full FCR-D activation can be seen. For the worst case the stability is reduced with 65 % when FCR-D is fully activated.

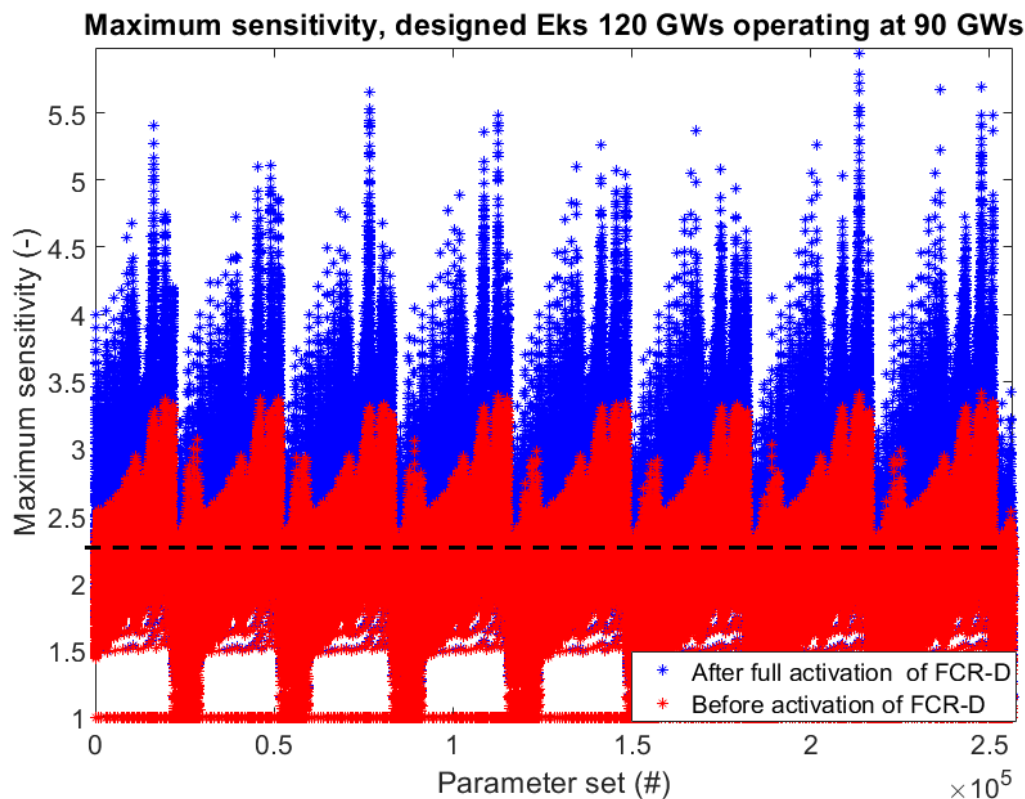


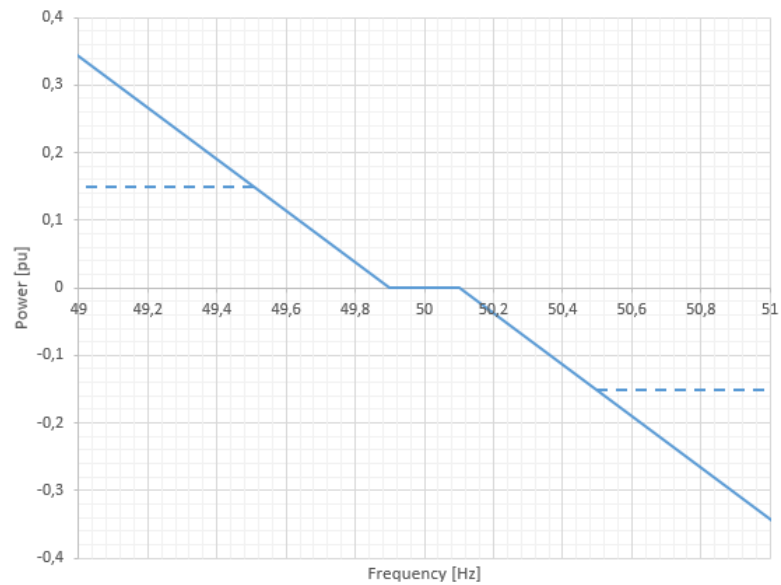
FIGURE 15. CLOSE LOOP STABILITY AT 120 GWs ASSESSED AT 90 GWs. THE BLACK DASHED LINE INDICATES THE DESIGNED MAXIMUM SENSITIVITY (2.31) AT 120 GWs.

## 2.7 STABILITY EVALUATION FOR SATURATING UNITS

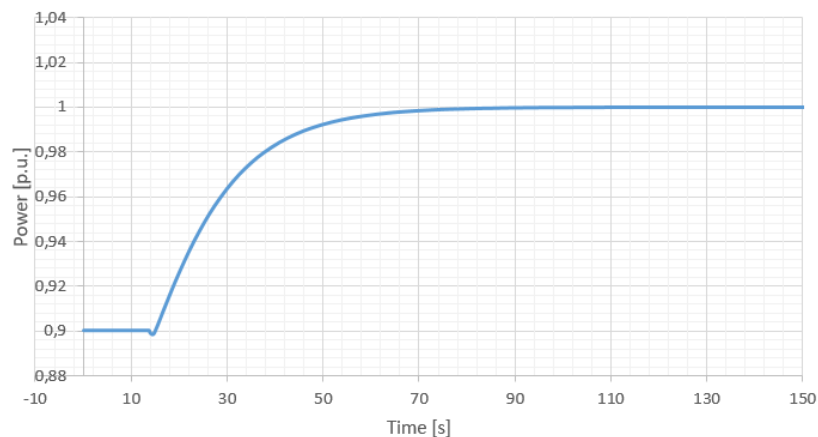
Both the TSOs and the producers have interests when assessing the impact of saturation on a unit delivering FCR-D, that is reaching maximum production at a stationary frequency deviation higher than 49.5 Hz. From a TSO perspective it is important that the saturation does not impact the system negatively, either by limiting the reserves delivered to the system or other phenomena related to performance or stability. On the other hand it is beneficial for both TSOs and producers to have units able to deliver FCR-D without unnecessary limitations.

### 2.7.1 BACKGROUND

The previous design made in FCP-project [1] includes a requirement stating that the FCR-D should be linearly activated over the frequency band 49.5-49.9 Hz (and 50.1-50.5 Hz), shown in Figure 16. This implies that saturation is not allowed between 49.5 and 50.5 Hz. Therefore, the prequalification tests for documenting stationary FCR-D activation will always result in a step response without saturation, as shown in Figure 17. This is the base case for evaluating the impact of saturating units, and finding a possible adaption in order to allow it.

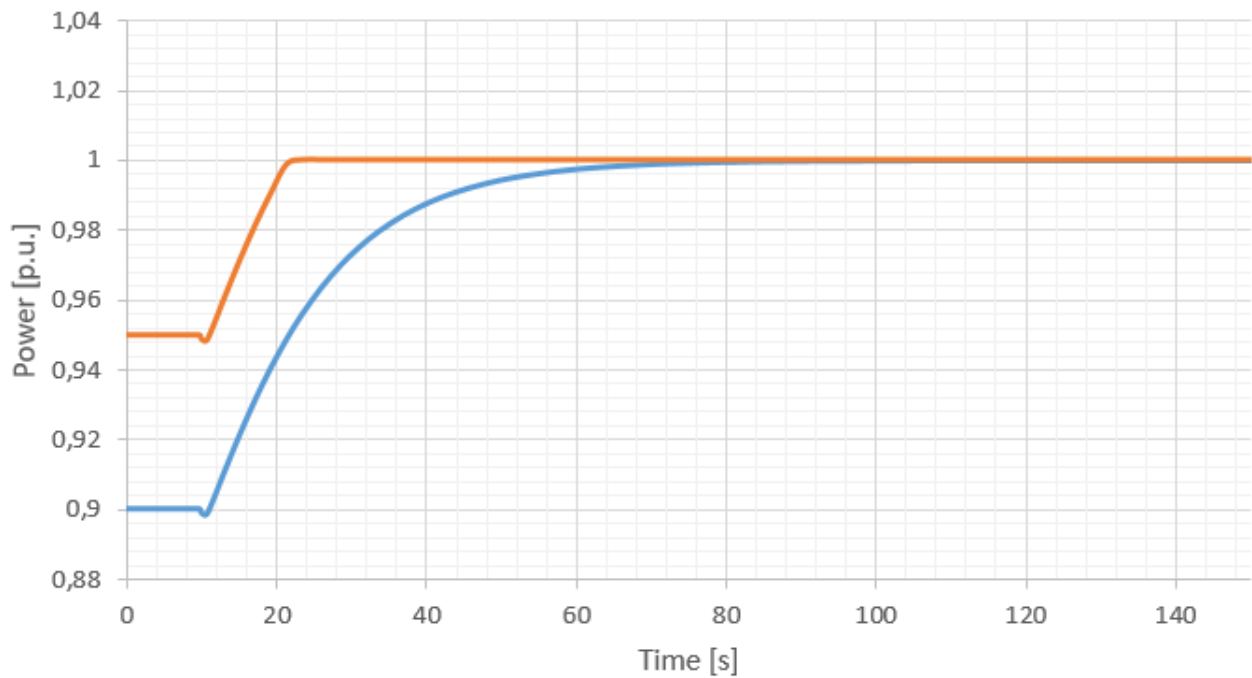


**FIGURE 16: RELATION BETWEEN STEADY STATE POWER RESPONSE AND FREQUENCY DEVIATION FOR A SINGLE UNIT DELIVERING FCR-D. DASHED LINE IS SATURATION, WHICH IS ALLOWED AT FREQUENCIES <49.5 AND >50.5 Hz WITHOUT ADDITIONAL CONSIDERATIONS NECESSARY FOR STABILITY REQUIREMENT.**



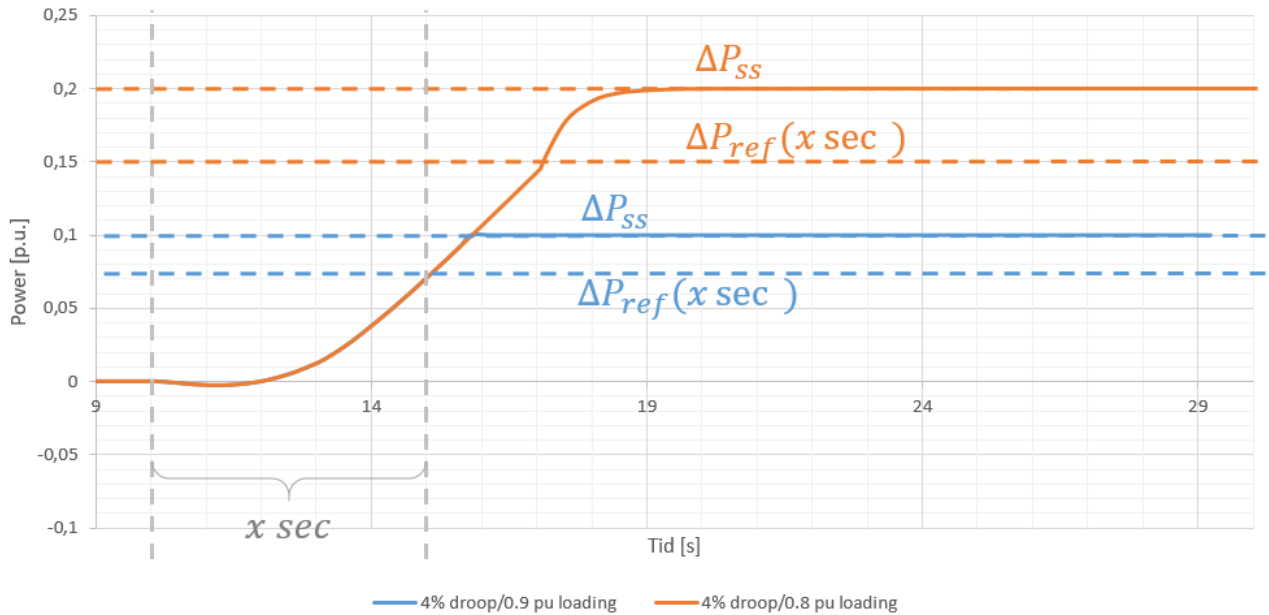
**FIGURE 17: EXAMPLE OF A -0.4 Hz STEP RESPONSE FOR A UNIT RUNNING THE TEST FOR DOCUMENTING THE STEADY STATE DELIVERY OF FCR-D**

The same unit (the same water time constant, the same PID parameters and the same droop) will saturate however if the setpoint is high enough. This will prevent the same power response to be activated compared to Figure 17, shown in Figure 18.



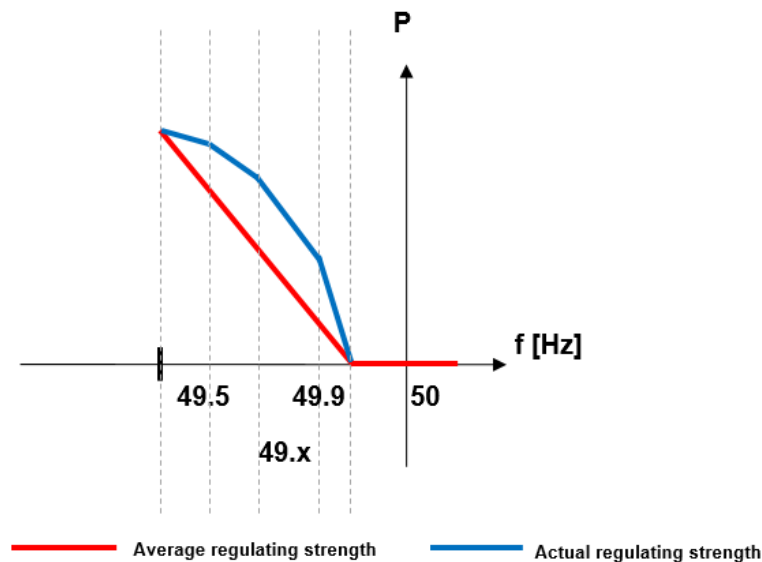
**FIGURE 18: EXAMPLE OF A -0.4 Hz STEP RESPONSE FOR A UNIT RUNNING THE TEST FOR DOCUMENTING THE STEADY STATE DELIVERY OF FCR-D, BUT WITH SATURATION DUE TO MAXIMUM POWER BEING REACHED.**

Looking at the responses for the performance requirement (ramp response) for the same unit with and without saturation, it becomes obvious that the saturation impacts the results, see Figure 19. The unit with saturation is able to meet the reference power,  $P_{ref,x sec}$  at  $x sec$ , but the unit without saturation is not able to meet the reference. The ability to meet the reference is expressed as a scaling factor which is then incorporated in the stability requirement. The practical interpretation is that a unit not being able to meet the reference yields a need for additional reserves, and that increases the regulating strength, hence reducing the stability margins without adaptations of the stability requirements. The performance requirements and scaling factor are explained in [1]. The result is that the unit without saturation will have a tougher stability requirement, even though the unit is equal in every way, except set point. Or in other words, letting a unit saturate makes it easier to qualify on stability.



**FIGURE 19: FCR UNIT RESPONSE ON PERFORMANCE WITH SATURATION WITHIN THE FCR-D FREQUENCY BAND OF 49.5-50.5 Hz (BLUE) AND WITHOUT SATURATION WITHIN THE FCR-D FREQUENCY BAND (ORANGE). THE UNIT IS IDENTICAL BETWEEN THE TWO RESPONSES, EXCEPT SETPOINT.**

The problem arising from this "easy qualification" is visible only when scaling to system level. The impact of saturation is a non-linear regulating strength over the FCR-D frequency band, as some units reach maximum power at a frequency higher than 49.5 Hz. Even though the average regulating strength of the system is the same, the maximum regulating strength will be higher. The non-linear regulating strength is illustrated in Figure 20.



**FIGURE 20: ILLUSTRATION OF NON-LINEAR RELATION BETWEEN STEADY STATE POWER RESPONSE AND FREQUENCY DEVIATION WITHIN THE FCR-D RANGE DUE TO SATURATION.**

One of the design principles for the design of requirement is that a single unit scaled to system level should comply with the system requirements (stability and performance) [1]. For a non-saturating

**Main point:** Units saturating affect the regulating strength of the system gain. When scaling a single unit to system level the increased gain of the FCR provider can be expressed by the relation between the average, and maximum regulating strength in the FCR-D frequency region at unit level.

unit, a unit scaled to system level with 3625 MW/Hz regulating strength and  $\Delta f = df = 0.4 \text{ Hz}$  ( $df$  defined in [1]), gives a power rating of 10875 MW, according to (2.6).

If a unit saturates however, the maximum FCR response is provided at  $\Delta f < df$ . Referring to equation 2.6, this will result in a higher rated power in the system. E.g. a unit saturating at 49.7 Hz scaled to system the system, the rated power becomes 21750 MW in order to meet the 1450 MW capacity stationary FCR response.

$$S_{n,FCR-D} = e_p dP \frac{f_0}{\Delta f} \tag{2.6}$$

The reference model developed in [1] is given by Figure 21. It is apparent that the rating of the FCR unit is proportional with the open loop gain of the FCR unit, and hence affect the stability of the system. The challenge is to include an additional requirement for units saturating, in order to account for the reduced stability.

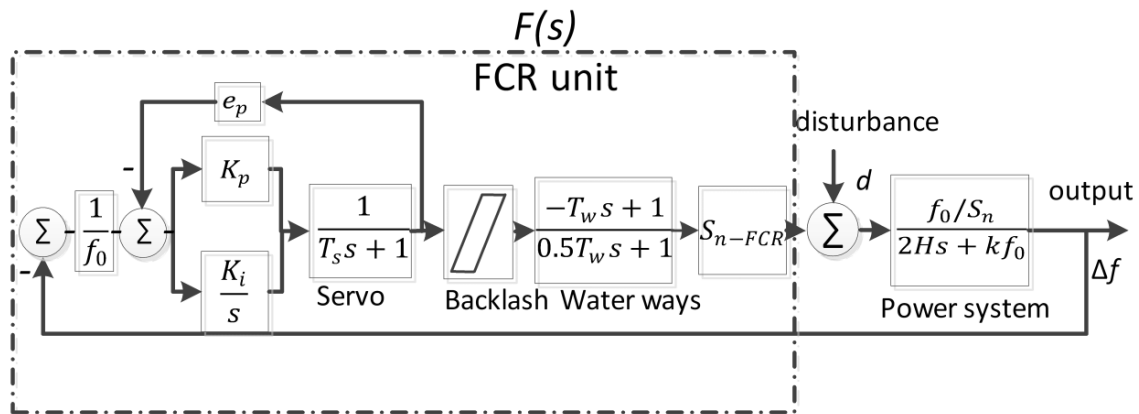


FIGURE 21: NON-LINEAR AGGREGATED REFERENCE MODEL

### 2.7.2 SOLUTION

By using the knowledge from the previous subsection, the technical requirements for stability is adapted to account for saturation. In addition, a prequalification test is developed.

The increased in gain can be generalized as a factor,  $K_{sat}$ , defined by the relation between the maximum regulating strength and the average regulating strength over the FCR-D range at unit level. The factor will always be higher than 1. This is expressed as

$$K_{sat} = \frac{\frac{(1-P_{set})}{\Delta f_{sat}}}{\frac{1-P_{set}}{df}} = \frac{df}{\Delta f_{sat}} \tag{2.7}$$

Referring to the test procedure in [5] and the verification of the stability requirement [1], the grid transfer function is given as,

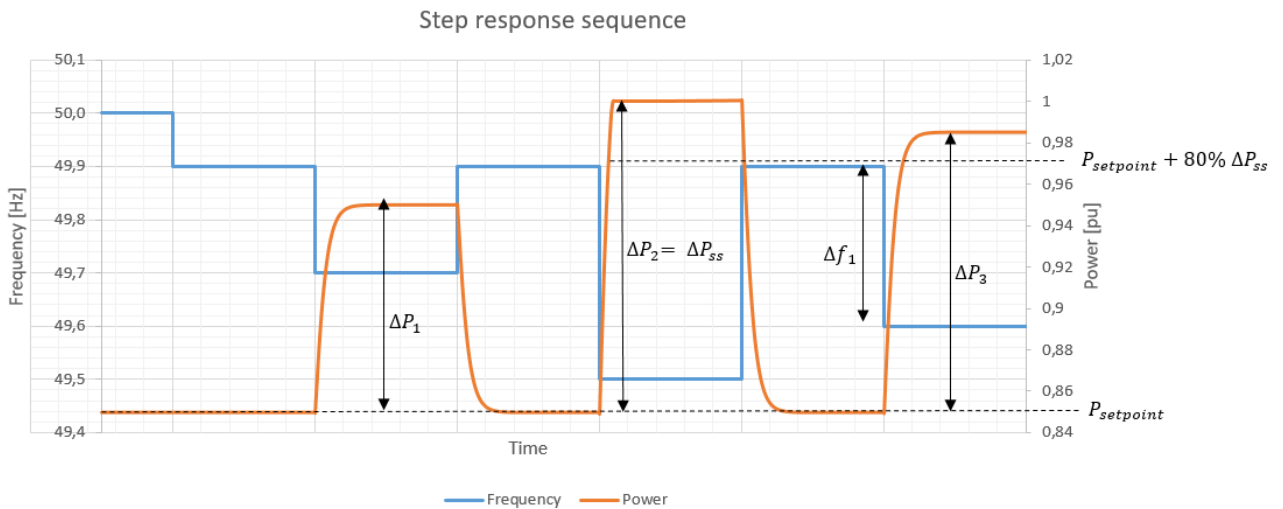
$$-\frac{\Delta P_{SS}}{C_{FCR-D}} \frac{1450 \text{ MW}}{0.4 \text{ Hz}} \frac{f_0}{S_{n-min}} \frac{1}{2H_{ks}S + k_f f_0} \quad (2.8)$$

When evaluating the stability, an increase in FCR unit regulating strength by the factor  $K_{sat}$  is equal to an increase of system gain by  $K_{sat}$ . This can be seen in equation (2.2). Including the factor in the grid transfer function gives

$$-K_{sat} \frac{\Delta P_{SS}}{C_{FCR-D}} \frac{1450 \text{ MW}}{0.4 \text{ Hz}} \frac{f_0}{S_{n,WC}} \frac{1}{2H_{wc}S + K_{f,wc}f_0} \quad (2.9)$$

To determine the saturation factor in testing,  $K_{sat}$ , the regulating strength,  $R \left[ \frac{\text{MW}}{\text{Hz}} \right]$ , for the unit in the non-saturated range must be found. The regulating strength between the loading,  $P_{set} \text{ [MW]}$ , and the maximum power is used to determine the increased regulating strength. A step response large enough to give more than 80% of the FCR-D stationary response (available reserves) should be applied to ensure that the regulation strength represents the average regulating strength in the range where the unit does not saturate. An example with notations is shown in Figure 22. The regulation strength is then calculated by equation as

$$K_{sat} = \frac{R_{max}}{R_{avg}} = \frac{\frac{\Delta P_3}{\Delta f_1}}{\frac{\Delta P_{SS}}{\Delta f_1}} = \frac{\Delta P_3}{\Delta f_1} \frac{df}{\Delta P_{SS}} \quad (2.10)$$



**FIGURE 22: EXAMPLE OF PREQUALIFICATION TEST TO DETERMINE THE SATURATION FACTOR**

### 2.7.3 REQUIREMENT

A unit saturating must first fulfill the stability requirements in derived in [1]. In addition an extra saturation factor,  $K_{sat}$  is included to the grid transfer function, given by equation (2.9). The saturation factor,  $K_{sat}$ , is defined by the relation between maximum and the average regulating strength, given by equation (2.10).



## 2.7.4 PREQUALIFICATION

For entities saturating, an additional step must be performed in addition to the two steps performed for FCR-D providing units without saturation. The step response sequence consists of three major frequency steps downwards, where the applied frequency is shown in Figure 23. The sequence is performed to document the stationary capacity (second step) and the actual regulating strength of the unit (last step). The first step is to include backlash when documenting stationary capacity. For each step performed the next step shall not be performed until the active power response has stabilized.

The last step (49.90 → 49.xx Hz) shall be large activate more than 80% of the stationary FCR-D activation.

50.00 Hz → 49.90 → 49.70 → 49.90 → 49.50 → 49.90 → 49.xx Hz

Each new step performed shall not be made until the active power response from the previous step has stabilized.

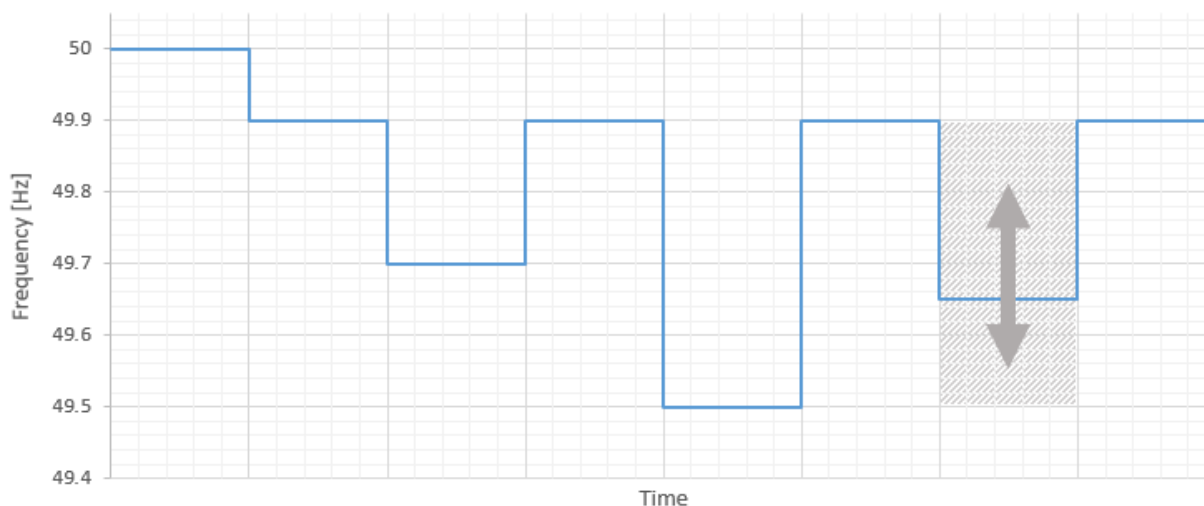


FIGURE 23: FCR-D UPWARDS REGULATION STEP RESPONSE SEQUENCE FOR UNITS SATURATING.

## 2.8 CONCLUSION AND DISCUSSION

The results of the qualification process made show that in order to qualify roughly 100 % of the required FCR-D capacity in Finland, the kinetic energy for fulfilling the performance requirements has to be increased to more than 300 GWs. As it is possible to qualify enough capacity in Sweden and Norway regardless of the chosen value of kinetic energy, only the possibilities to qualify capacity in Finland have to be considered. If the performance requirement is dimensioned for a kinetic energy lower than 300 GWs, the qualified capacity from hydro power units in Finland will be reduced below 100 %. Finland today has a significant amount of capacity from loads as well but it has already been accounted for in the goal to qualify only 100 % of the FCR-D obligation (instead of 150-200 % like for Sweden and Norway). The goal of 100 % considers that the qualified units are not operating all the time and that there is a need for liquidity in the market.

On the other hand, increasing the kinetic energy in order to qualify more FCR-D capacity also increases the need for fast frequency reserve (FFR) in terms of both hours and capacity. It should be noted that FRR could be provided by resources that can also provide FCR-D. Figure 25 shows an overview of need for FFR for different choices of kinetic energy for FCR-D performance requirement:

- Assuming that units operate 80 % loading, the kinetic energy for performance is around 300 GWs in order to reach 100% of the national obligation in Finland (base case)
- If it is assumed that the units operate at 70 % loading instead of 80 %, 100 % of the national obligation in Finland is reached at around 220 GWs.
- Norway reaches 100 % of their national obligation at 100 GWs (at 80 % loading)
- Sweden reaches their national obligation at 120 GWs (at 80 % loading)
- The Nordic power system as a whole reaches 1450 MW qualified capacity at around 110 GWs

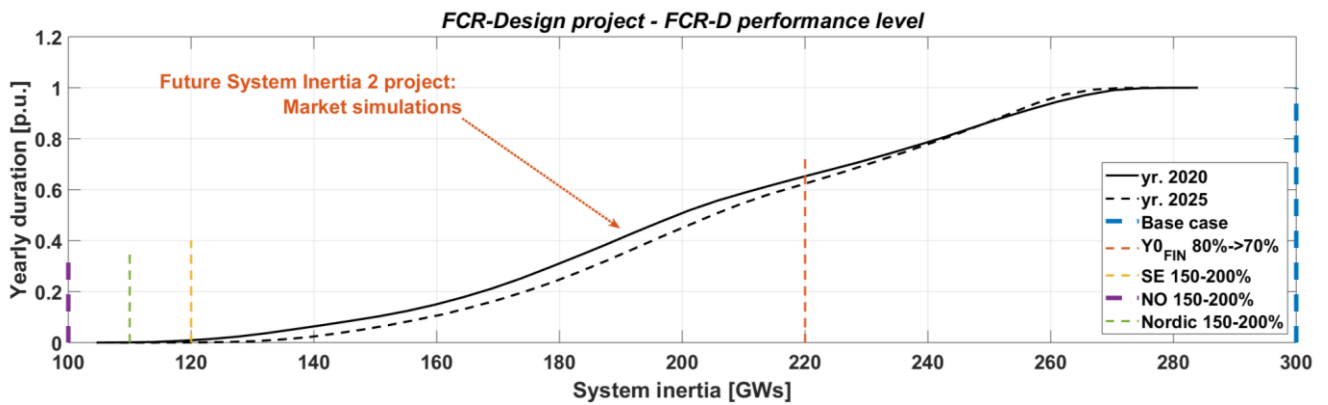


FIGURE 24. MARKET SIMULATIONS PERFORMED IN THE FUTURE SYSTEM INERTIA PROJECT [6].

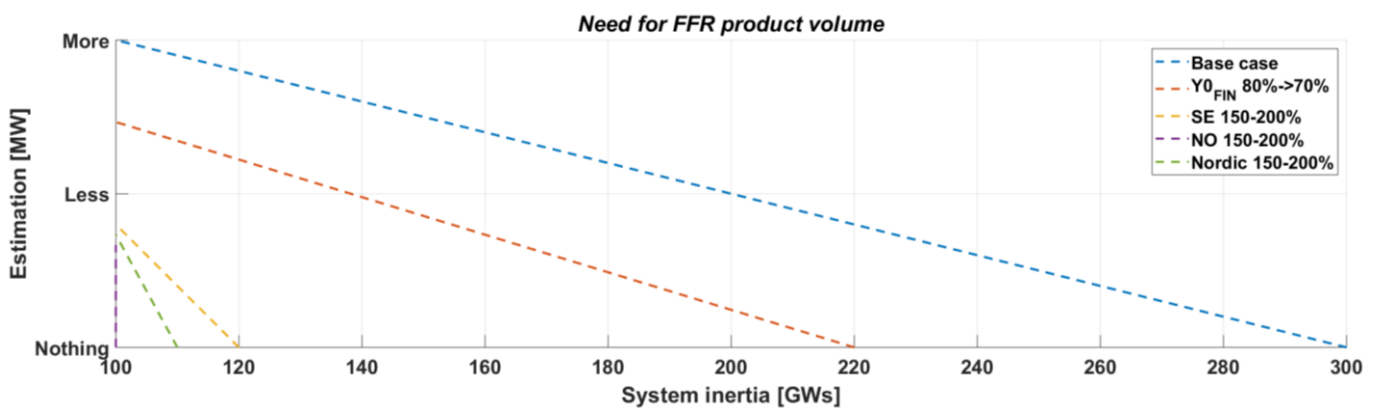


FIGURE 25. OVERVIEW – NEED OF FAST FREQUENCY RESERVE (FFR) AS A CHOICE OF FCR-D KINETIC ENERGY FOR PERFORMANCE.

## 2.9 FURTHER WORK

One way to increase the qualified FCR-D capacity could be to allow the use of marginally stable, or even unstable, FCR-D governor parameters for a short time, after which the unit must switch to a

parameter set that meets the stability requirement to ensure that the power system maintains stability. This kind of solution is likely to enable the providers to qualify more capacity as the stability requirement would not limit the tuning of the turbine governor.

Given that the FCR-D performance requirement is strongly related to the system need for FFR, it is evident that both FCR-D and FFR must be considered when deciding on the kinetic energy for which FCR-D performance requirement is dimensioned. The choice will be a trade-off between the qualified capacity from hydro power units in Finland and the needed FFR volume. In order to find a balanced solution, further work on FFR is needed. This work has already been initiated and will include development of a technical specification and analysis on the needed FFR capacity.

## 3. SWITCH OVER BETWEEN FCR-N AND FCR-D

### 3.1 BACKGROUND

In the overall scheme of frequency control, differentiating between Frequency Containment Reserve for stochastic imbalances (FCR-N), and disturbances (FCR-D), both in terms of capacities and requirements, gives rise to an issue for units delivering both products. Based on studies performed and requirements developed it is a reasonable assumption that there is a need for different parameter setting of the governor for FCR-N and -D. Due to this conclusion, it is important to study the consequences for the system if there are continuously switching of parameter sets in units delivering both FCR-N and FCR-D.

#### 3.1.1 EVALUATION

Evaluation of the effect of parameter switching can have different levels of detail. The most stringent approach would be to require that units delivering both FCR-N and -D should have as good, or better, performance as two units delivering them separately. However, the requirements for FCR-N and -D are largely verified using sin-in sin-out-test, and/or ramp responses without discontinuities. Therefore, there is no clear way to evaluate the combined performance of FCR-N and -D. A more nuanced approach is that the system should not suffer noticeably negatively under the effect of switching parameters.

As a baseline for the evaluation lies the general approach for FCR-design of requirements - that a unit scaled to global level should comply with the system requirements. Under the assumption that a unit qualifies for both FCR-N and -D, the products comply individually both for performance, and stability, but what is the system requirement for passing the threshold between the two products? Firstly – the investigation need to be made on a system level to highlight the possible problems, i.e. closed loop simulations need to be performed. Secondly – the behavior should be testable, i.e. it must be possible to observe the parameter switching in an open loop frequency test sequence.

A deviation would typically be deviations from expected steady state frequency (based on knowledge of the steady state behavior of them separately). Other responses include transient behavior for power during crossings of the threshold and switching of parameters. Such discontinuities can under the right circumstances cause problems. The main concern is continuous activation and deactivation around the threshold, e.g. switching from FCR-N to FCR-D or vice versa giving an aggressive power response triggering new frequency transients leaving the system oscillating between FCR-N and -D frequency ranges. Another non-desirable effect from power and frequency transients in the system, is triggering of voltage oscillations and rotor swings.

Main point: The response from a system with production units supplying both FCR services having conventional switching of parameters between FCR-N and FCR-D should not severely deviate from the system response when the FCR services are supplied from separate units.

### 3.1.2 TWO PRODUCTS

First, a presentation of the purpose and criteria for activation of FCR-N and -D is needed, to contextualize the need for switch over. The Frequency Containment Reserve for normal operation (FCR-N) shall handle the short term stochastic power variation in production and consumption. The normal frequency band is  $50 \pm 0.1$  Hz which should not be exceeded more than 15 000 minutes per year [1]. The goals for the FCR-D reserves, are to make sure that the power balance is restored before 49.0 Hz (51.0 Hz) and to keep the steady state frequency above 49.5 Hz (below 50.5 Hz) [1]. Note that the frequency requirements for FCR-D reserves are referred to a system state at the borderline of the normal frequency band, 49.9 Hz (50.1 Hz), so that the frequency deviation requirements are 0.9 Hz transiently and 0.4 Hz stationary.

The technical requirements [7] state that the FCR reserves from a production unit, both FCR-N and -D, should steady state be linearly activated over the interval 49.9-50.1 Hz and 49.5-49.9 Hz/50.1-50.5 Hz respectively. To deliver only one or the other service a dead band and/or a saturation on the frequency measurement are used in the analyses in this report. A dead band of  $\pm 0.1$  Hz allows only delivery of FCR-D, saturation at 49.9 and 50.1 Hz allows only delivery of FCR-N. Consequently, deactivation of both dead band and saturation gives delivery of FCR-N and -D from the same unit. This is illustrated in Figure 26 and summarized in Table 6.

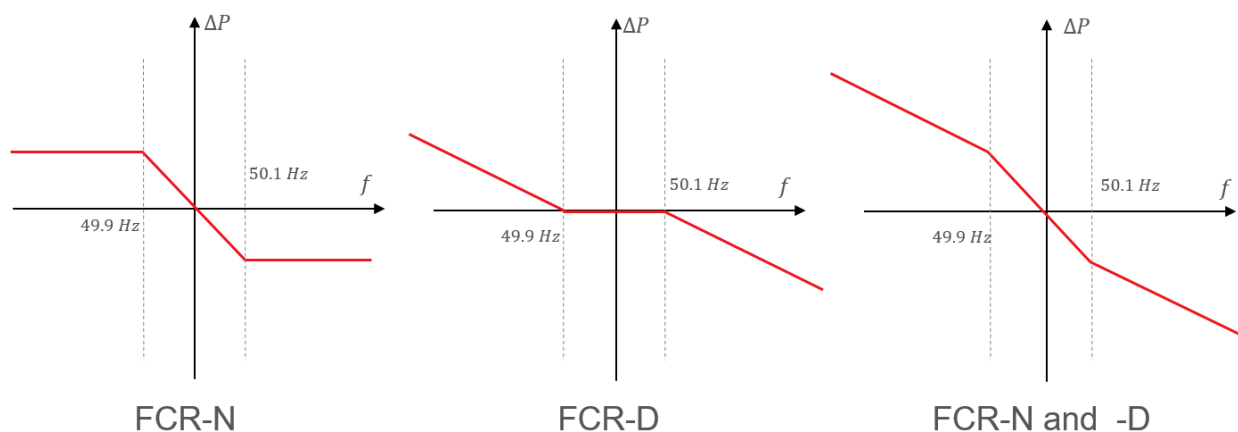


FIGURE 26: DROOP PROFILE ON SYSTEM LEVEL FOR FCR-N, FCR-D AND FOR THEM COMBINED.

TABLE 6 PARAMETERS FOR COMPLYING WITH REQUIREMENT FOR LINEAR ACTIVATION OF FCR-N AND –D.

Delivery	PID	Frequency measurement		Droop
		Dead band	Saturation	
FCR-N	Parameter set qualified for FCR-N	0 Hz	0.1 Hz	Droop qualified for FCR-N
FCR-D	Parameter set qualified for FCR-D	0.1 Hz	Deactivated (Not allowed)	Droop qualified for FCR-D
FCR-N and -D	Two parameter sets qualified for FCR-N and –D respectively	0 Hz	Deactivated	Two droop settings qualified for FCR-N and –D respectively

Moving from the context of the system needs, the discussion is focused on the unit level. Fundamental for the discussion on switching parameters, is the conclusion that FCR-N and –D can (or will) require different parameter sets, as stated in the motivation. This will require some sort of switching at the threshold between the two products. The core of the problem lies in the fact that even though there are two products, for example in a hydro unit, there is only one guide vane, penstock, turbine and generator. Hence, the solution, and problem, must be located internally in the governor.

### 3.1.3 CASES

The simulations are made in a qualitative manner, meaning that a parameter set with representative properties and parameter settings is used for both FCR-N and –D throughout the simulations. The changing of the parameters are made individually according to what is being studied. In other words, it is initially assumed that FCR-N and –D are using the same parameter sets. Then the impact from switching parameters individually, assuming it is necessary, can be studied.

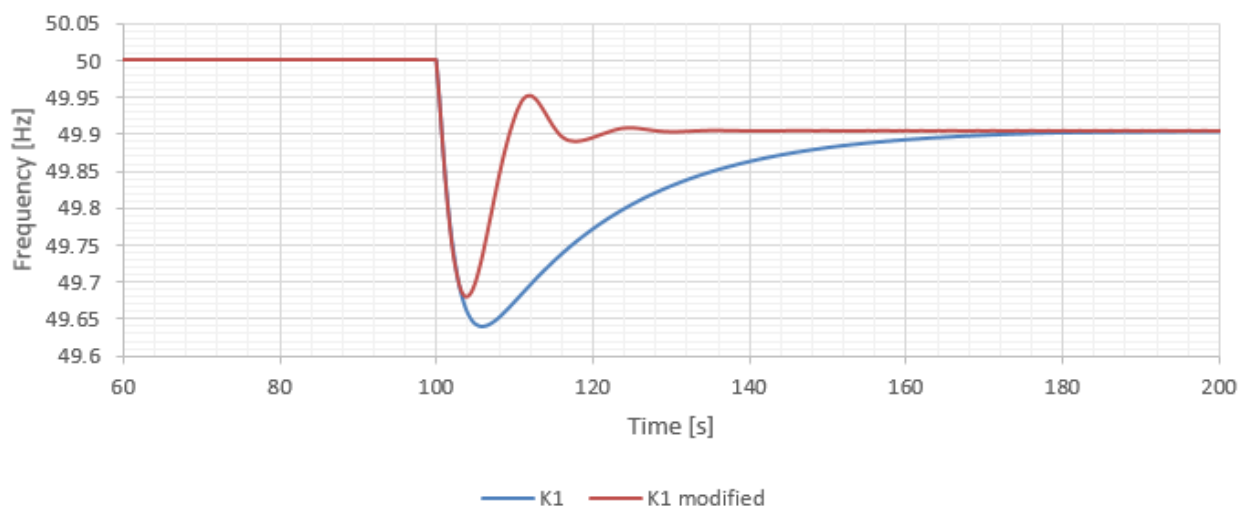
The default settings for both FCR-N and –D are derived from the linear optimization in the FCR-N design of requirements [1]. However, the integral gain,  $K_i$ , is increased as compared to the K1 set (from 0.41 to 3). The reason for this is to make the system more oscillating, see Figure 27, such that the simulations result in more crossings of the switching threshold, i.e. at 49.9/50.1 Hz. This, however, mean that the stability margins are reduced, but since the simulations are qualitative (effect of changing from the base case), this is deemed to be of no importance. The PID parameters, see Table 8, are used for a production unit with properties according to Table 7.

**TABLE 7 PARAMETERS USED FOR THE SIMULATED PRODUCTION UNIT.**

Parameter	Value
Water time constant, $T_w$	1.2 sec
Servo time constant, $T_y$	0.2 sec

**TABLE 8 DEFAULT GOVERNOR PARAMETER SET USED FOR THE SIMULATIONS.**

Parameter	Value
Proportional gain FCR-N, $K_{p,FCR-N}$	7.436
Integral gain FCR-N, $K_{i,FCR-N}$	3
Derivative gain FCR-N, $K_{D,FCR-N}$	0
Droop FCR-N, $e_{p,FCR-N}$	0.06
Proportional gain FCR-D, $K_{p,FCR-D}$	7.436
Integral gain FCR-D, $K_{i,FCR-D}$	3
Derivative gain FCR-D, $K_{D,FCR-D}$	0
Droop FCR-D, $e_{p,FCR-D}$	0.06

**FIGURE 27 EFFECT OF MODIFYING THE K1 PARAMETER SET TO GET OSCILLATIONS IN THE SYSTEM.**

### 3.1.3.1 BASE CASE

The base case simulation model is based on the reference model from the FCP project [1], see Figure 28. A base case for evaluation is constructed, where separate units deliver FCR-N and -D together. This is modelled as two separate FCR units in parallel as can be seen Figure 29.

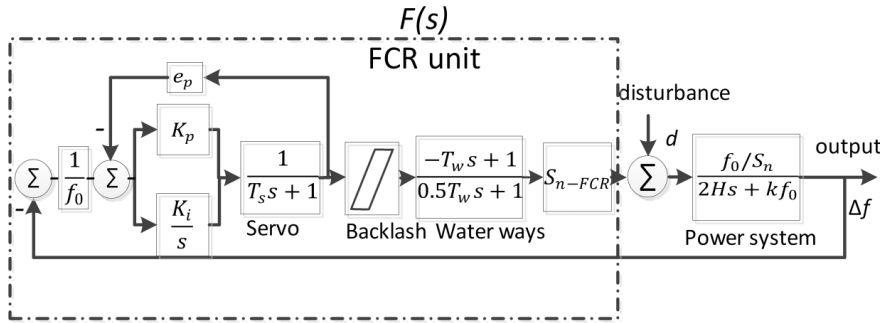


FIGURE 28 NON-LINEAR AGGREGATED REFERENCE MODEL.

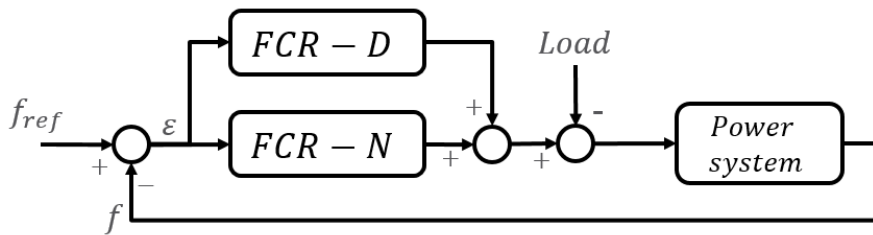


FIGURE 29 MODEL OF A SYSTEM WITH FCR-N AND -D SUPPLIED SEPARATELY.

### 3.1.3.2 SYSTEM SCALING FOR FCR-UNITS WITH PARAMETER SWITCHING

To maximize the impact of parameter switching on a system level, all the simulations are adapted so that a maximum amount of FCR-N and -D are supplied from units supplying both, i.e. are equipped with switching. The share depends on the droop settings of FCR-N and -D. For example, with  $e_{p,FCR-N} = 0.06$  and  $e_{p,FCR-D} = 0.06$ , and dimensioning regulating strengths  $R_{FCR-N} = 6000 \frac{MW}{Hz}$  and  $R_{FCR-D} = 3625 \frac{MW}{Hz}$ , then the total rating for FCR-N and -D providing units are  $S_{n,FCR-N} = 18000$  MW and  $S_{n,FCR-D} = 10875$  MW. As it is specified that a maximum share of the units should supply both FCR-N and -D a total rating of 10875 MW of FCR-supplying units (the lower of the two) are delivering both products and a total rating  $18000 - 10875 = 7125$  MW FCR-units are delivering only FCR-N.

The model used is based on the reference model, see Figure 28, and adapted to support the approach of maximizing the rating of units supplying both FCR-N and -D, see Figure 29. This is done by including a parallel branch (two FCR-units in a lumped mass model) supplying residual FCR reserves, FCR-N or -D. The default parameters used give a share of units according to Table 9. Note that the values depend on the droop and are therefore changed accordingly in the different analyses.

TABLE 9 NOMINAL POWER FOR FCR PROVIDING UNITS WHEN THE AVERAGE DROOP OF FCR-N AND FCR-D IS 6%, PROCURED CAPACITIES OF 600 MW (6000 MW/Hz) AND 1450 MW (3625 MW/Hz) RESPECTIVELY.

Units supplying	Nominal power
$S_{n,FCR-N+FCR-D}$	10875 MW
$S_{n,FCR-N}$	7125 MW
$S_{n,FCR-D}$	0 MW



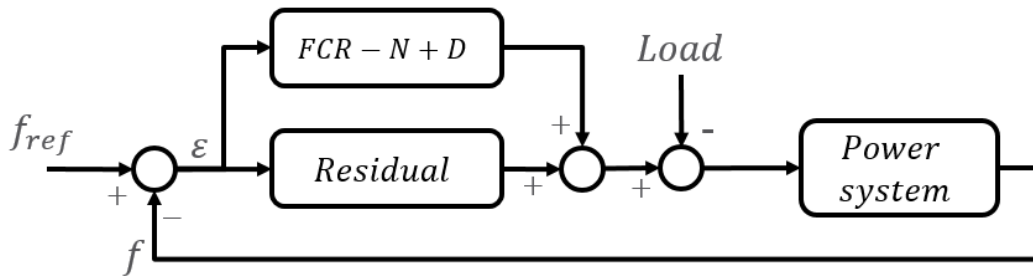


FIGURE 30 MODELLING A SYSTEM WITH FCR-N AND -D PARTLY SUPPLIED FROM UNITS DELIVERING BOTH FCR-N AND -D, AND THE RESIDUAL FCR DELIVERED FROM A PARALLEL BRANCH.

### 3.1.3.3 CONVENTIONAL REGULATOR WITH PARAMETER SWITCHING

The branch supplying both FCR-N and -D in Figure 30 is modelled as a conventional regulator with parameter switching at  $\Delta f = 0.1 \text{ Hz}$ , see Figure 31 and Figure 32. Two individual parameter sets complying with FCR-N and -D respectively are activated and deactivated at the threshold.

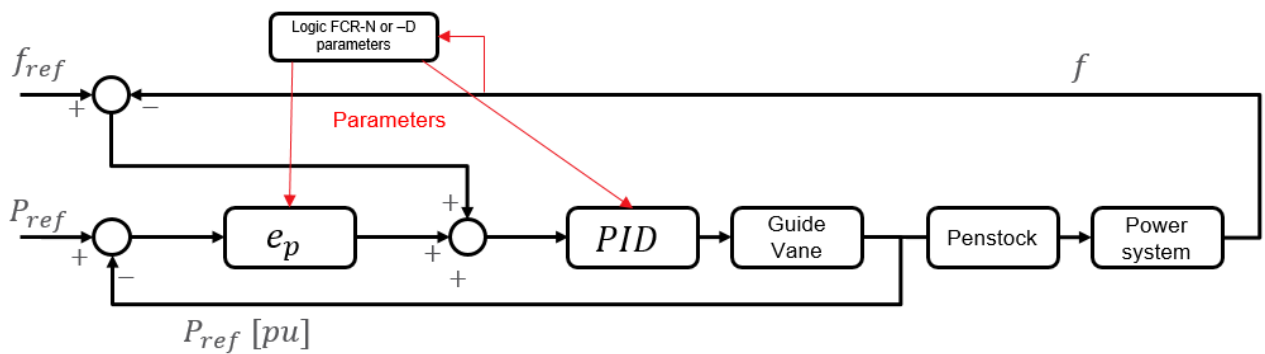


FIGURE 31 SCHEMATIC (SIMPLIFIED) FREQUENCY CONTROL SYSTEM WITH GATE FEEDBACK AND SWITCHING OF PARAMETERS AT THE FREQUENCY THRESHOLD.

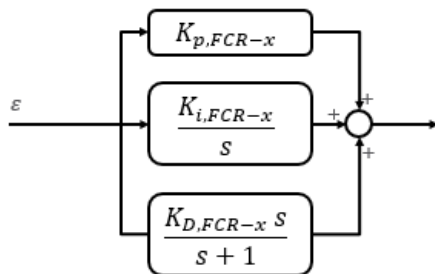


FIGURE 32 PID-STRUCTURE AND PARAMETERS NOTATION. THE FCR-X REFERS TO EITHER PARAMETER SET FOR FCR-N OR -D.

### 3.1.3.4 PARALLEL STRUCTURE WITH PARAMETER SWITCHING

An approach has been proposed in preparation for solving potential problems observed by switching of parameters, which is presented in chapter 3.2. A governor with parallel PID-regulators and droop feedback (from PID-output), gives the option for individual routing of frequency deviation, by using

saturation for the FCR-N PID-regulator and dead band for the FCR-D PID-regulator. FCR-N and -D are then controlled separately. The PID-structures are as in Figure 32.

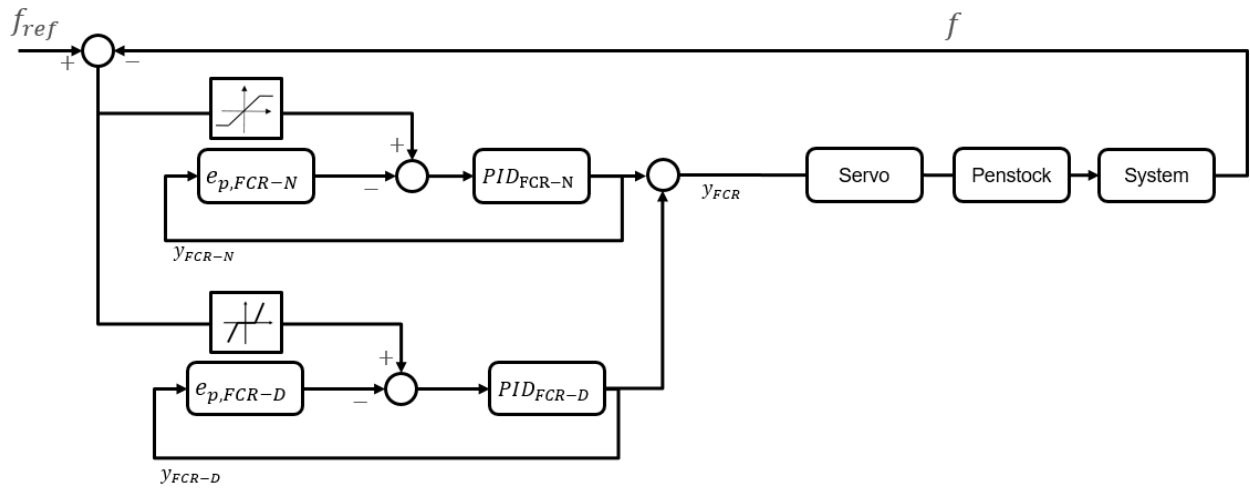


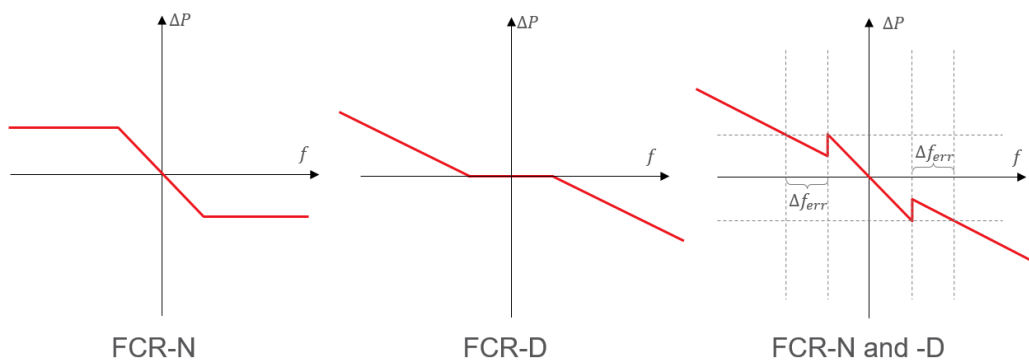
FIGURE 33 SCHEMATIC (SIMPLIFIED) FREQUENCY CONTROL WITH PID FEEDBACK AND PARALLEL REGULATORS FOR FCR-N AND -D.

## 3.2 SIMULATION RESULTS

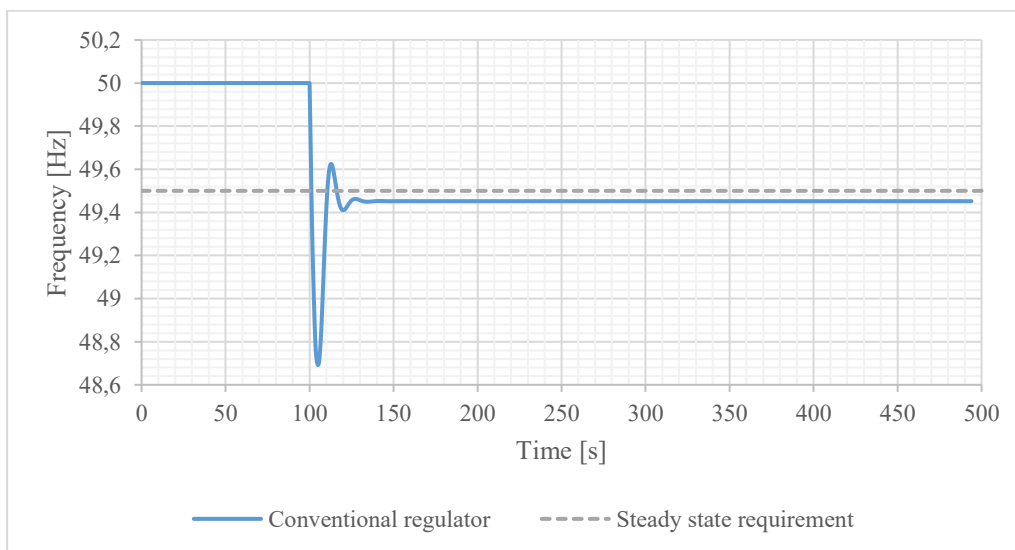
### 3.2.1 STEADY STATE

#### 3.2.1.1 SWITCHING $e_p$

Referring to the approaches from chapter 3.1.3, using a conventional controller with switching of droop at 49.9 Hz (or 50.1 Hz) will give a non-desirable response depending on the relation between the two settings. If the FCR-N droop is lower than the FCR-D droop a share of power will be deactivated when crossing the threshold. On a global level, this means that the steady state frequency deviation will have an additional error,  $\Delta f_{err}$ . The droop characteristics are illustrated in in Figure 34, and the phenomena is illustrated from the simulation results in Figure 35. The dashed line in Figure 35 is the requirement for steady state frequency (FCR-N and FCR-D combined), but due to the switching with a conventional controller, there will be a greater frequency deviation.



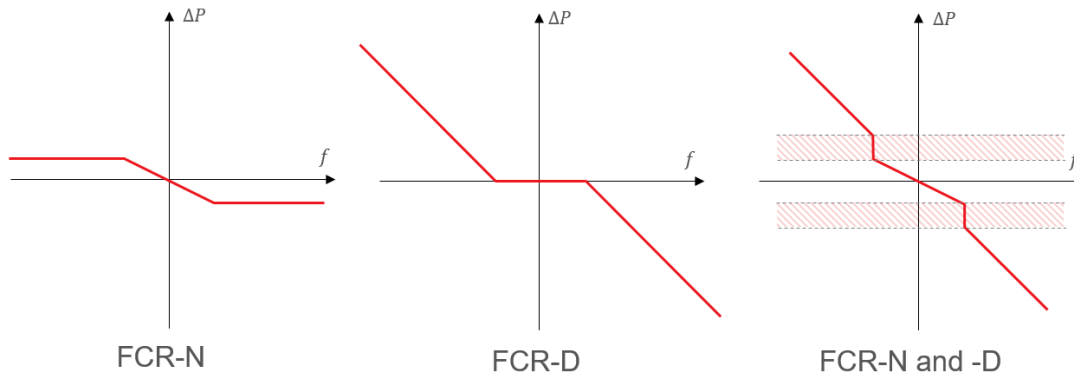
**FIGURE 34** STEADY STATE RELATIONSHIP BETWEEN POWER CHANGE AND FREQUENCY DEVIATION (DROOP PROFILE) OF A CONVENTIONAL REGULATOR WITH SWITCHING OF DROOP AT A THRESHOLD ( $e_{p,FCR-N} < e_{p,FCR-D}$ )



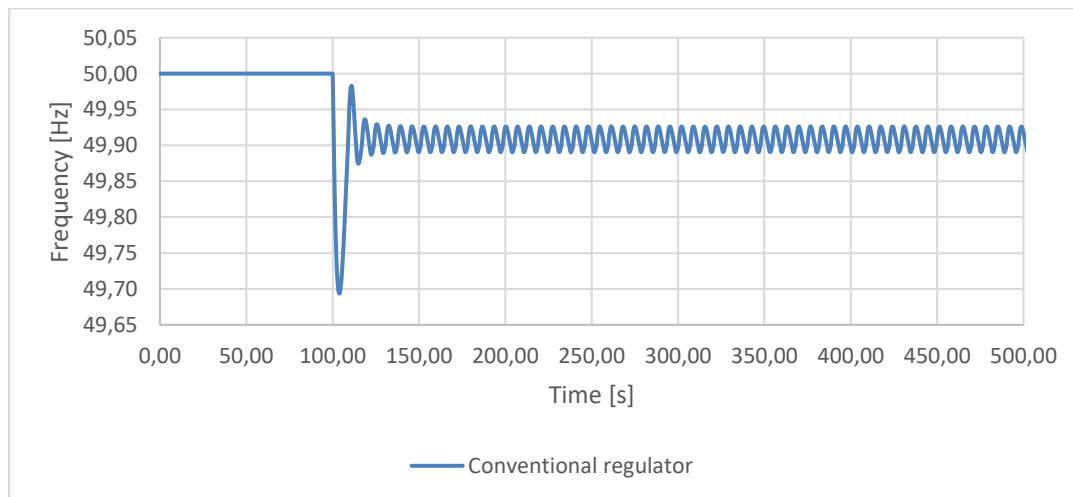
**FIGURE 35** FREQUENCY RESPONSE OF A SYSTEM WITH A CONVENTIONAL REGULATOR SWITCHING BETWEEN  $e_{p,FCR-N} = 0.04$  AND  $e_{p,FCR-D} = 0.08$ . THE IMPOSED POWER IMBALANCE IS 2050 MW.

On the other hand, if the FCR-N droop is higher than the FCR-D droop, there is a possibility that there is no equilibrium point at a given imbalance in the system. This can cause a limit cycle which

is an oscillation caused by the non-linearity in the system. The case with a higher FCR-D droop is illustrated in the droop characteristics in Figure 36 and simulated in Figure 37.



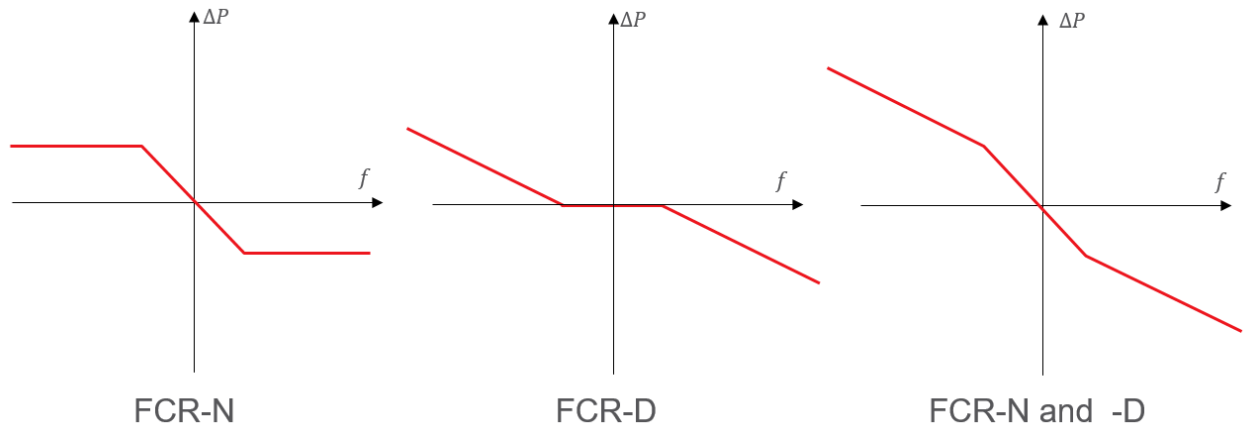
**FIGURE 36** STEADY STATE RELATIONSHIP BETWEEN POWER CHANGE AND FREQUENCY DEVIATION (DROOP PROFILE) FOR A CONVENTIONAL REGULATOR WITH SWITCHING OF DROOP AT A THRESHOLD ( $e_{p,FCR-N} > e_{p,FCR-D}$ ).



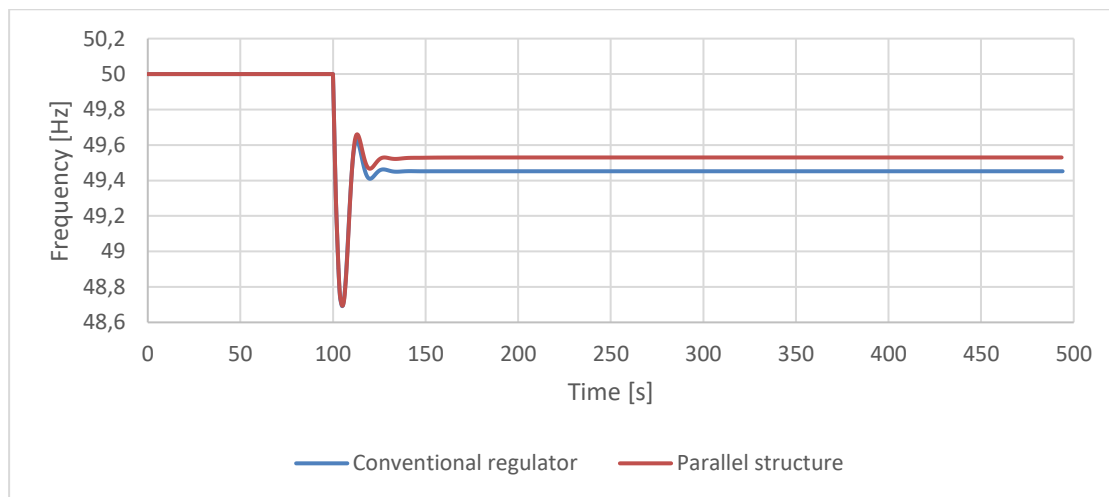
**FIGURE 37** FREQUENCY RESPONSE OF A SYSTEM WITH A CONVENTIONAL REGULATOR SWITCHING BETWEEN  $e_{p,FCR-N} = 0.08$  AND  $e_{p,FCR-D} = 0.04$ . THE IMPOSED POWER IMBALANCE IS 600 MW.

From Figure 34 and Figure 36 it is obvious that the droop profile for delivering both FCR-N and -D from a conventional regulator with switching, is not equal to the sum of the two if the droop setting is not the same. If FCR-N and -D have different droop settings within a unit, considerations are therefore needed in order to maintain the steady state activation at the threshold  $\Delta f = 0.1 \text{ Hz}$ , so that droop characteristic doesn't jump, i.e.  $\Delta P(\Delta f_{FCR-N} = 0.1^- \text{ Hz}) = \Delta P(\Delta f_{FCR-N} = 0.1^+ \text{ Hz})$ . This is equivalent of saying that the total steady state FCR-response must be equal to the sum of the two products delivered individually for all operating points and frequency deviations. This is illustrated in the droop characteristics in Figure 38.

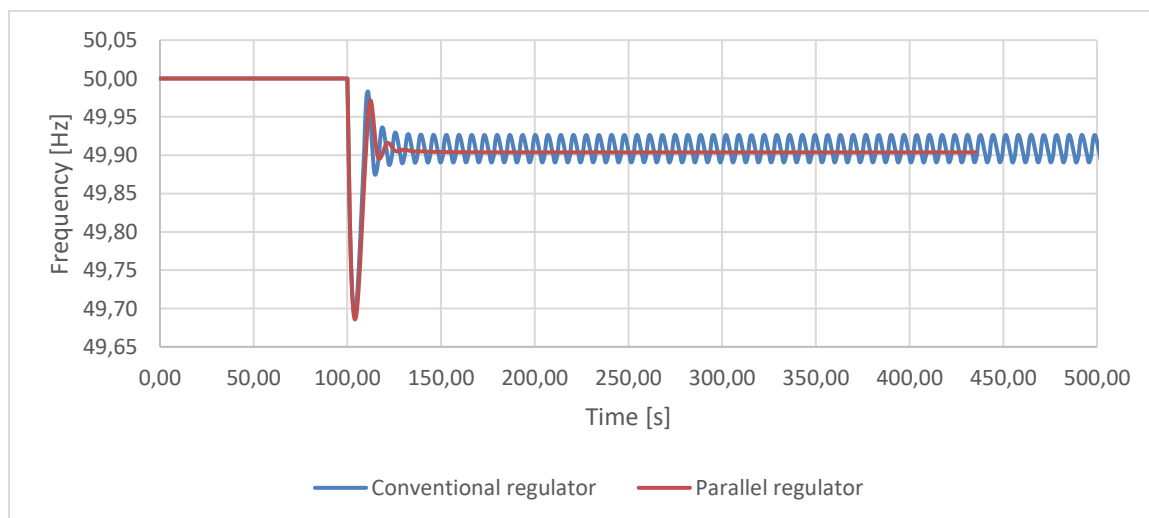
In Figure 39 and Figure 40 simulations are made using both the conventional regulator and the parallel regulator structure presented in chapter 3.1.3. In Figure 39 the frequency deviation becomes lower for the model with parallel regulator structures, as the activated FCR-N is maintained at the threshold. In Figure 40 the limit cycle is eliminated, as the regulator with parallel structure gives equilibrium points for any given imbalance, unlike the conventional regulator (illustrated in Figure 36). Hence, the parallel regulator structure fulfils the requirements for steady state activation of FCR-N and -D simultaneously also when having different droop settings of FCR-N and FCR-D.



**FIGURE 38** STEADY STATE RELATIONSHIP, DROOP PROFILE, OF A REGULATOR WITH PARALLEL STRUCTURE.



**FIGURE 39** FREQUENCY RESPONSE OF A SYSTEM WITH CONVENTIONAL REGULATOR STRUCTURE (BLUE) AND PARALLEL REGULATOR STRUCTURE (RED), SWITCHING BETWEEN  $e_{p,FCR-N} = 0.04$  AND  $e_{p,FCR-D} = 0.08$ . THE POWER IMBALANCE IS 2050 MW.



**FIGURE 40** FREQUENCY RESPONSE OF A SYSTEM WITH CONVENTIONAL REGULATOR STRUCTURE (BLUE) AND PARALLEL REGULATOR STRUCTURE (RED), SWITCHING BETWEEN  $e_{p,FCR-N} = 0.08$  AND  $e_{p,FCR-D} = 0.04$ . THE POWER IMBALANCE IS 600 MW.

### 3.2.2 DYNAMIC PARAMETERS

The concern regarding the dynamic behavior is that continuous parameter switching of PID parameters in the governor causes transients in the system and oscillations around 49.9 Hz or 50.1 Hz. A qualitative method is used here in order to highlight problematic behaviors by isolating the switching of the different PID parameters. The droop is maintained constant. The same model as used when studying the steady state behavior when changing of the droop setting is used, so that a maximum share of units is delivering both FCR-N and -D, i.e. are switching between parameters. The response from a conventional governor with parameter switching, is compared to a system where the FCR products are supplied from separate units.

From the Table 8 parameters, the effect of switching the parameters is investigated by isolating each of them by introducing different parameters for FCR-N and -D;

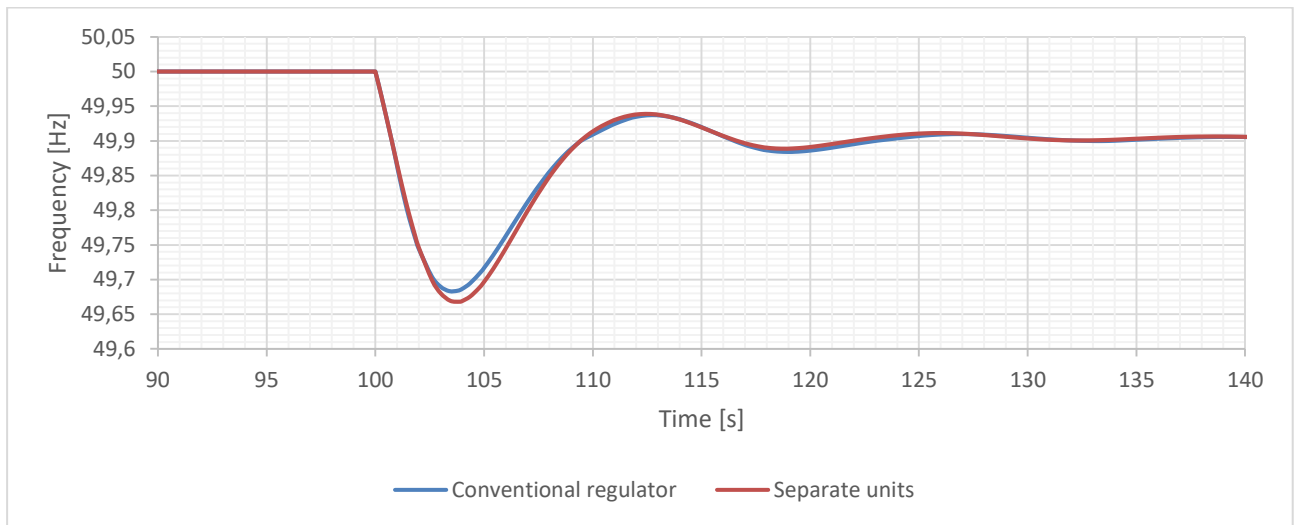
- Proportional gain
  - $K_{p,FCR-N} = 4.436$  and  $K_{p,FCR-D} = 10.436$
  - $K_{p,FCR-N} = 10.436$  and  $K_{p,FCR-D} = 4.436$
- Integral gain
  - $K_{i,FCR-N} = 0.2$  and  $K_{i,FCR-D} = 4$
  - $K_{i,FCR-N} = 4$  and  $K_{i,FCR-D} = 0.2$
- Derivative gain
  - $K_{D,FCR-N} = 0$  and  $K_{D,FCR-D} = 8$
  - $K_{D,FCR-N} = 8$  and  $K_{D,FCR-D} = 0$

The parameter changes are in the outer ranges of the interval of swept parameters in the design of requirements [1]. Note that the actual prequalification of the parameters is not evaluated. By carefully choosing an imbalance resulting in steady state frequency close to 49.9 Hz, the impact of the switching of parameters can be observed in the oscillations before reaching steady state.

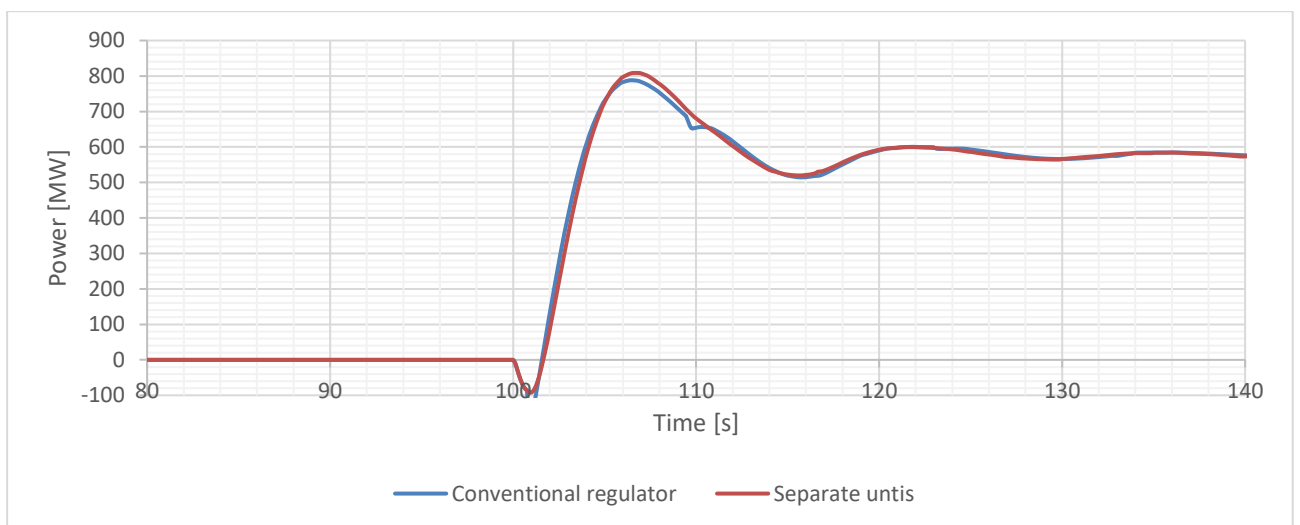
By changing the parameters so that  $K_{p,FCR-N} = 4.436$  and  $K_{p,FCR-D} = 10.436$ , the system responds as in Figure 41 and Figure 42. The effect of units switching with conventional controller (blue response) is marginal from the response from the base case (orange) and if anything, the frequency response is a bit improved by a reduced maximum frequency deviation. There are no transients which could potentially reduce system stability, but the "bumps" in power may be of influence from a producer point of view (a bump on system level implies bumps on unit level as well).

Changing the parameters so that  $K_{p,FCR-N} = 10.436$  and  $K_{p,FCR-D} = 4.436$ , results in the frequency and power response from Figure 43 and Figure 44. No unwanted transients are introduced to the system, but the "bumps" in active power may be of producer's interest to avoid.

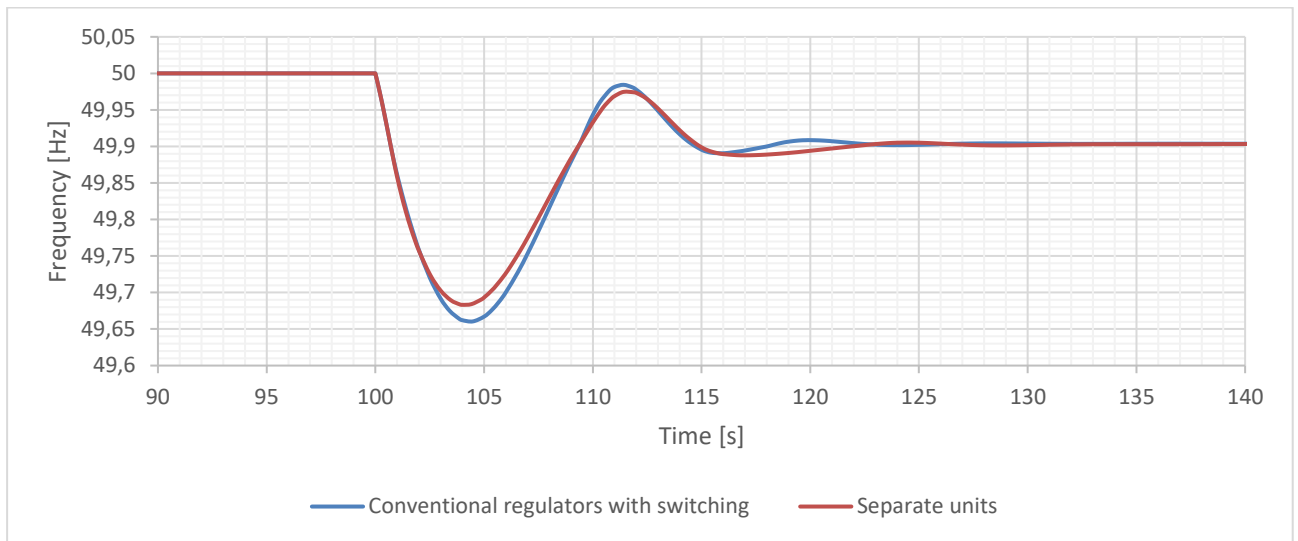
It concluded that switching of  $K_p$  with a conventional regulator does not impact the system frequency significantly. The results do indicate that crossing of the threshold ( $\Delta f = 0.1 \text{ Hz}$ ) and consequent switching do lead to a bump in power, which may be an unwanted behavior for producers.



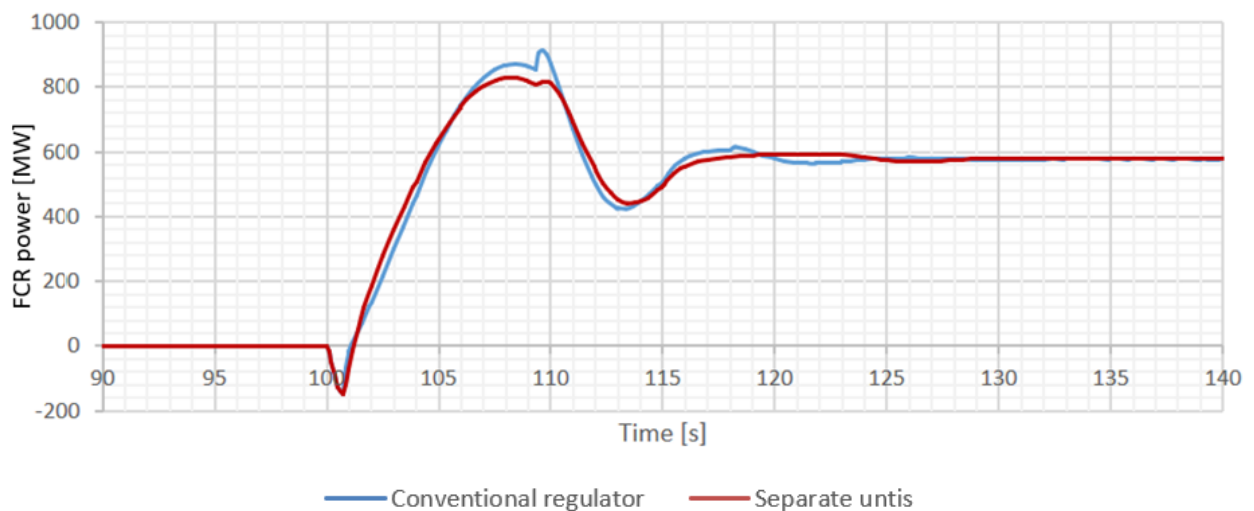
**FIGURE 41** FREQUENCY RESPONSE AFTER A 600 MW POWER STEP FOR A SYSTEM WITH SEPARATE UNITS SUPPLYING FCR-N AND -D (ORANGE), AND A SYSTEM WITH A SHARE OF FCR UNITS HAVING CONVENTIONAL REGULATOR SUPPLYING BOTH FCR-N AND -D (BLUE). PARAMETERS FROM TABLE 6, TABLE 7 AND TABLE 8, BUT WITH  $K_{p,FCR-N} = 4.436$  AND  $K_{p,FCR-D} = 10.436$ .



**FIGURE 42** FCR UNITS POWER RESPONSE AFTER A 600 MW POWER STEP FOR A SYSTEM WITH SEPARATE UNITS SUPPLYING FCR-N AND -D (ORANGE), AND A SYSTEM WITH A SHARE OF UNITS HAVING CONVENTIONAL REGULATOR SUPPLYING BOTH FCR-N AND -D (BLUE). PARAMETERS FROM TABLE 6, TABLE 7 AND TABLE 8, BUT WITH  $K_{p,FCR-N} = 4.436$  AND  $K_{p,FCR-D} = 10.436$ .



**FIGURE 43 FREQUENCY RESPONSE AFTER A 600 MW POWER STEP FOR A SYSTEM WITH SEPARATE UNITS SUPPLYING FCR-N AND -D (ORANGE), AND A SYSTEM WITH A SHARE OF FCR UNITS HAVING CONVENTIONAL REGULATOR SUPPLYING BOTH FCR-N AND -D (BLUE). PARAMETERS FROM TABLE 6, TABLE 7 AND TABLE 8, BUT WITH  $K_{p,FCR-D} = 4.436$  AND  $K_{p,FCR-N} = 10.436$ .**



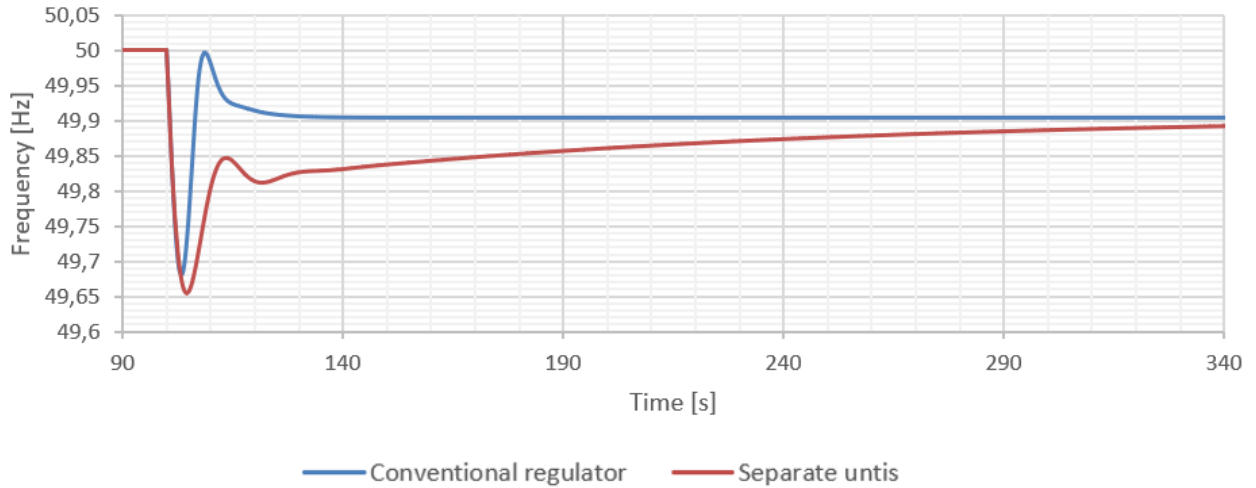
**FIGURE 44 FCR UNITS POWER RESPONSE AFTER A 600 MW POWER STEP FOR A SYSTEM WITH SEPARATE UNITS SUPPLYING FCR-N AND -D (ORANGE), AND A SYSTEM WITH A SHARE OF UNITS HAVING CONVENTIONAL REGULATOR SUPPLYING BOTH FCR-N AND -D (BLUE). PARAMETERS FROM TABLE 6, TABLE 7 AND TABLE 8, BUT WITH  $K_{p,FCR-D} = 4.436$  AND  $K_{p,FCR-N} = 10.436$ .**

The effect of the switching from  $K_{i,FCR-N} = 0.2$  to  $K_{i,FCR-D} = 4$  is marginal when it comes to frequency nadir, see Figure 45. It does, however, impact the time for activating the reserves as can be seen in Figure 46. Since FCR-N has a lower gain, the activation of FCR-N in the base case with separate units, is quite slow. With the conventional regulator, however, the threshold is crossed quickly and before FCR-N capacity is fully activated. Changing to FCR-D parameters for the units supplying FCR-N as well result in a quicker response. Never the less, there are no unwanted behaviours in the system.

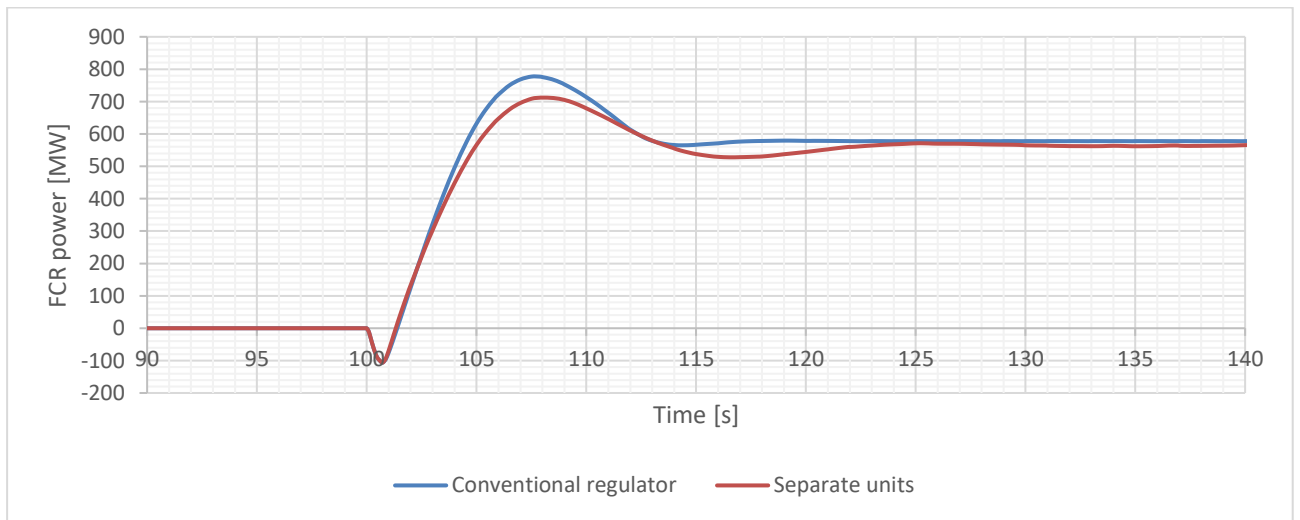
The switch is then studied for the opposite direction, i.e.  $K_{i,FCR-N} = 4$  and  $K_{i,FCR-D} = 0.2$ . Still, the response differs as compared to the case with separate units, see Figure 47 and Figure 48. However, the response is still not severely different in either frequency nadir or the transient behavior. The



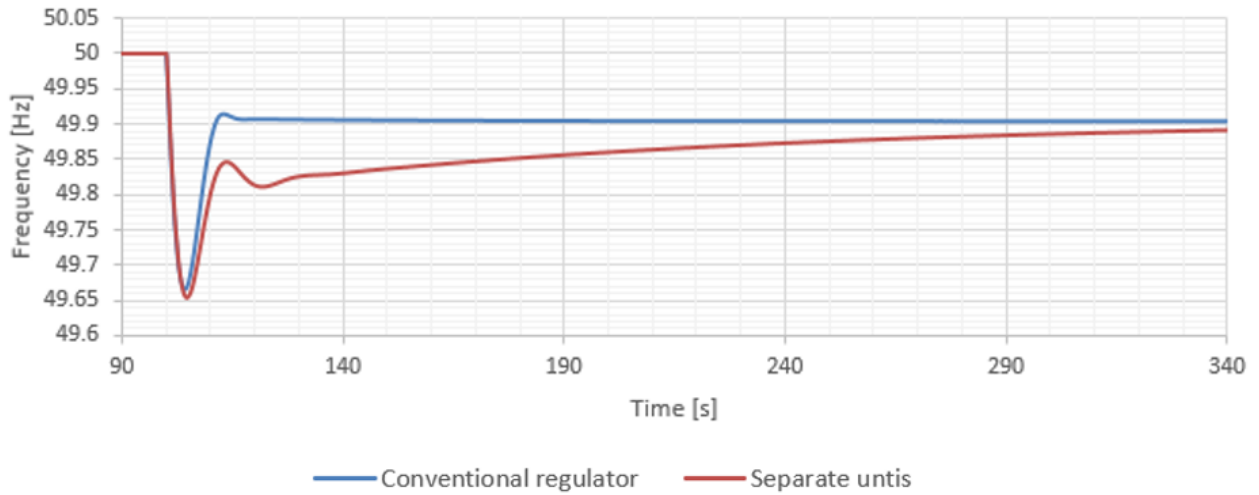
time it takes to fully activate the FCR capacity is once again affected by the same reason, that the conventional controller results in FCR-N being activated with a time constant of the FCR-D response.



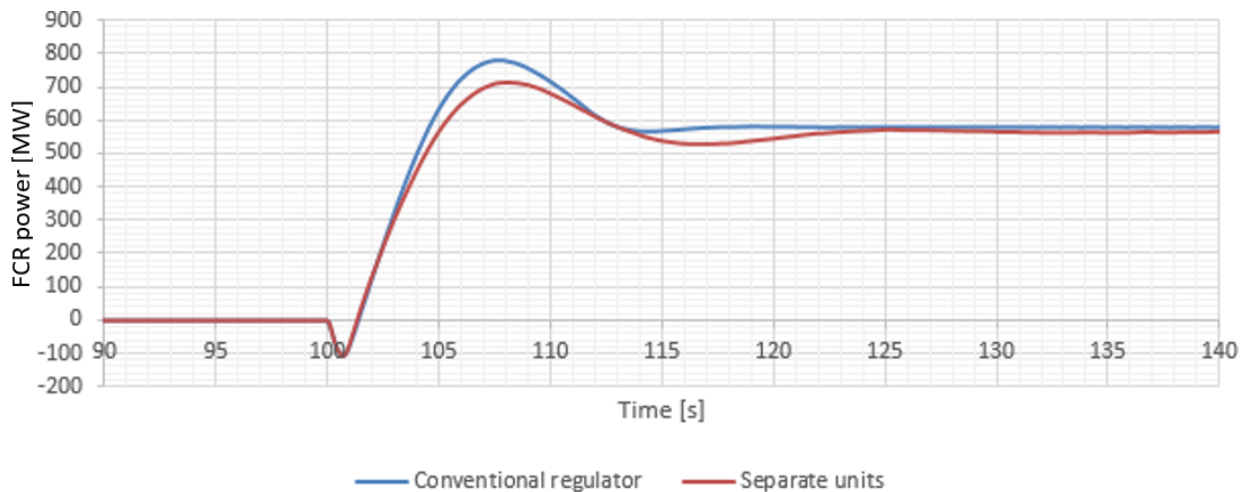
**FIGURE 45** FREQUENCY RESPONSE AFTER A 600 MW POWER STEP IN A SYSTEM WITH SEPARATE UNITS SUPPLYING FCR-N AND -D (ORANGE) AND A CONVENTIONAL REGULATOR SUPPLYING BOTH FCR-N AND -D (BLUE). PARAMETERS FROM TABLE 6, TABLE 7 AND TABLE 8, BUT WITH  $K_{i,FCR-N} = 0.2$  AND  $K_{i,FCR-D} = 4$ .



**FIGURE 46** FCR POWER RESPONSE AFTER A 600 MW POWER STEP IN A SYSTEM WITH SEPARATE UNITS SUPPLYING FCR-N AND -D (ORANGE), AND A CONVENTIONAL REGULATOR SUPPLYING BOTH FCR-N AND -D (BLUE). PARAMETERS FROM TABLE 6, TABLE 7 AND TABLE 8, BUT WITH  $K_{i,FCR-N} = 0.2$  AND  $K_{i,FCR-D} = 4$ .

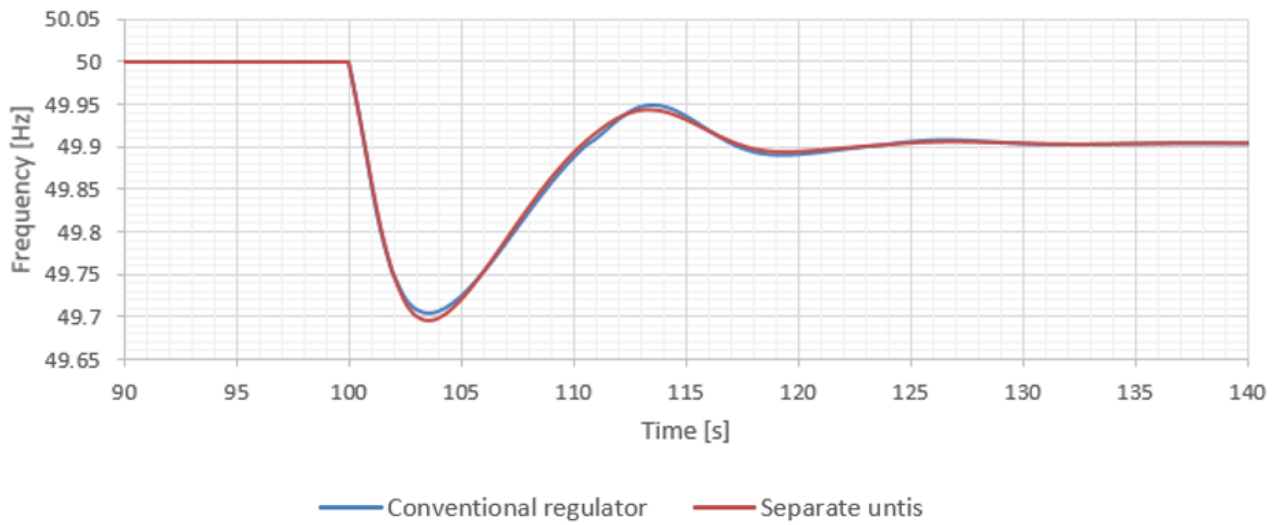


**FIGURE 47 FREQUENCY RESPONSE AFTER A 600 MW POWER STEP IN A SYSTEM WITH SEPARATE UNITS SUPPLYING FCR-N AND -D (ORANGE) AND A CONVENTIONAL REGULATOR SUPPLYING BOTH FCR-N AND -D (BLUE). PARAMETERS TABLE 6, TABLE 7 AND TABLE 8, BUT WITH  $K_{i,FCR-D} = 0.2$  AND  $K_{i,FCR-N} = 4$ .**

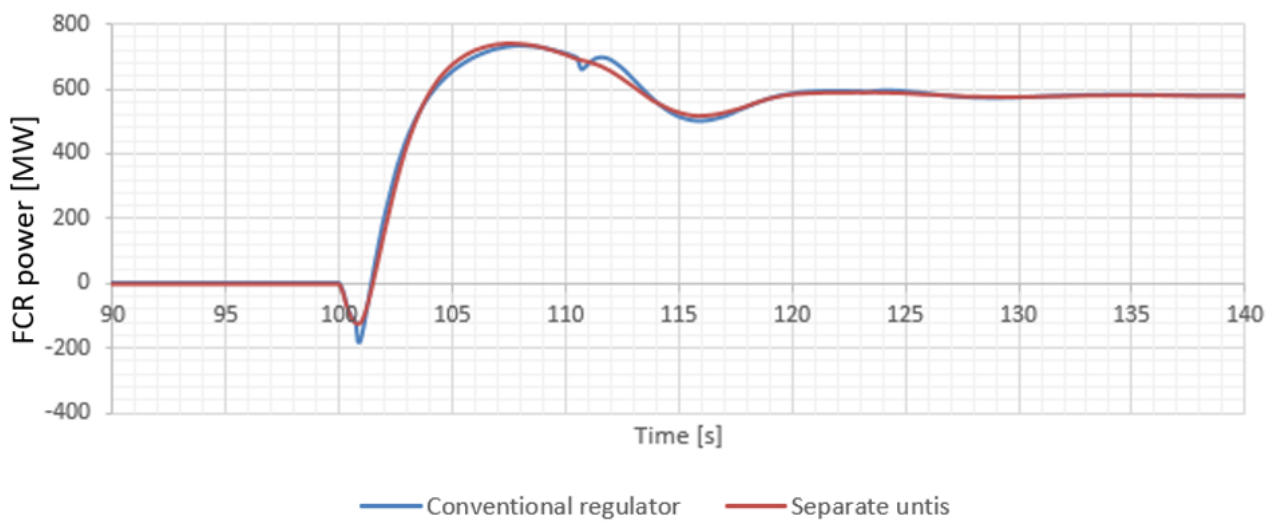


**FIGURE 48 FCR POWER RESPONSE AFTER A 600 MW POWER STEP IN A SYSTEM WITH SEPARATE UNITS SUPPLYING FCR-N AND -D (ORANGE), AND A CONVENTIONAL REGULATOR SUPPLYING BOTH FCR-N AND -D (BLUE). PARAMETERS FROM TABLE 6, TABLE 7 AND TABLE 8, BUT WITH  $K_{i,FCR-D} = 0.2$  AND  $K_{i,FCR-N} = 4$ .**

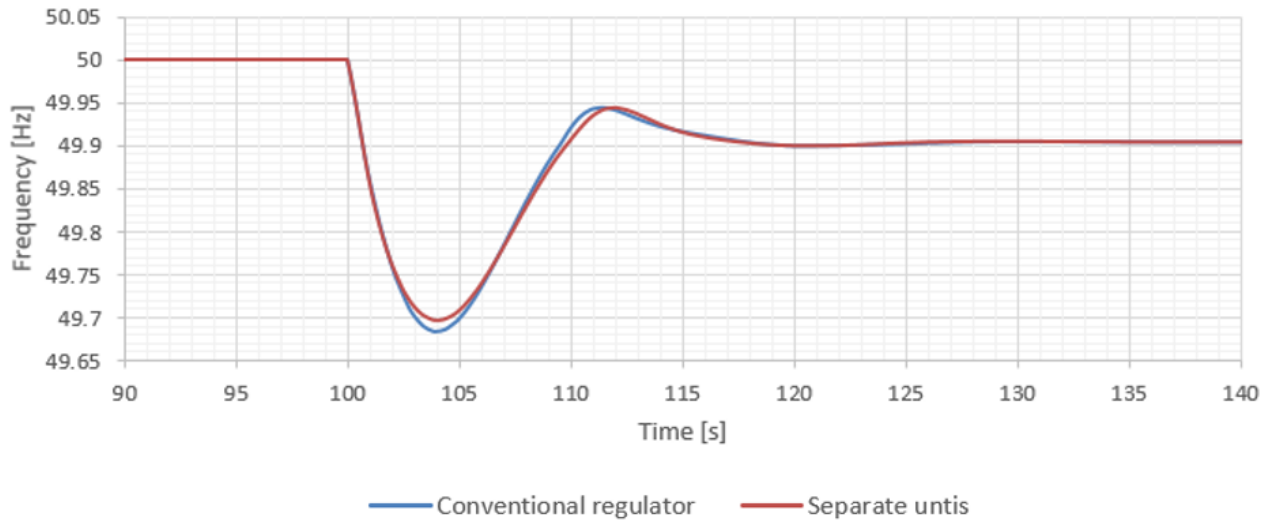
The effect of switching between  $K_{D,FCR-N} = 0$  and  $K_{D,FCR-D} = 8$  is almost indistinguishable as can be seen in Figure 49 and Figure 50. Turning the "direction" for the switching, so that  $K_{D,FCR-N} = 8$  and  $K_{D,FCR-D} = 0$ , results in the frequency and power response in Figure 51 and Figure 52. Comparing the response of units switching (blue response) with the response from separate units (orange), it can be concluded that switching of  $K_D$  with conventional regulator does not impact the system frequency response significantly. The results indicate that crossing of the threshold ( $\Delta f = 0.1 Hz$ ) and consequent switching lead to a bump in power, which may be an unwanted behavior for producers.



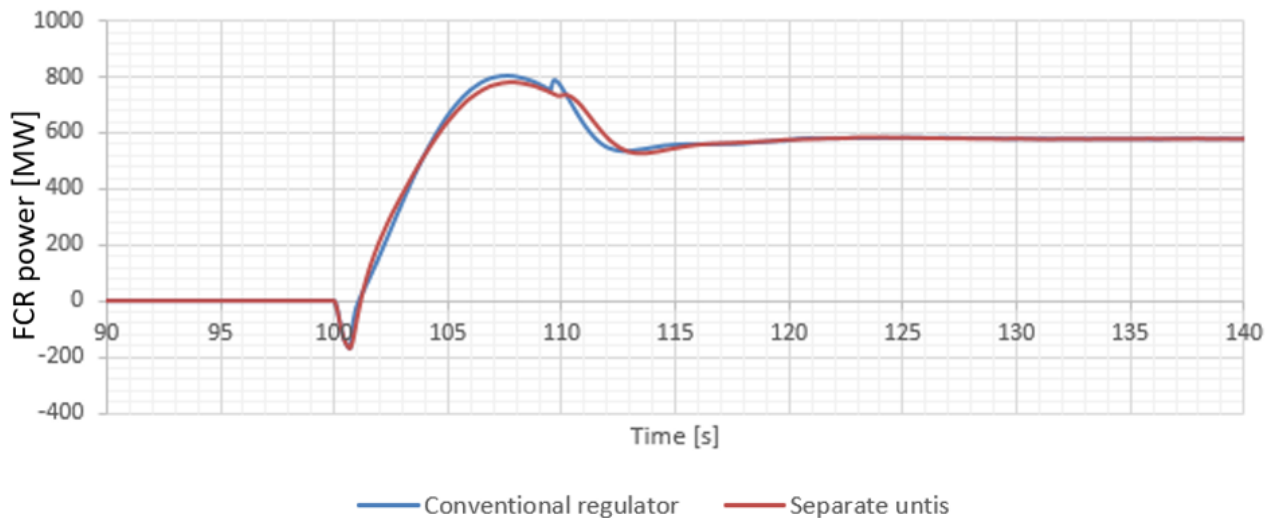
**FIGURE 49** FREQUENCY RESPONSE AFTER A 600 MW POWER STEP IN A SYSTEM WITH SEPARATE UNITS SUPPLYING FCR-N AND -D (ORANGE), AND A CONVENTIONAL REGULATOR SUPPLYING BOTH FCR-N AND -D (BLUE). PARAMETERS FROM TABLE 6, TABLE 7 AND TABLE 8, BUT WITH  $K_{D,FCR-N} = 0$  AND  $K_{D,FCR-D} = 8$ .



**FIGURE 50** FCR POWER RESPONSE AFTER A 600 MW POWER STEP IN A SYSTEM WITH SEPARATE UNITS SUPPLYING FCR-N AND -D (ORANGE), AND A CONVENTIONAL REGULATOR SUPPLYING BOTH FCR-N AND -D (BLUE). PARAMETERS FROM TABLE 6, TABLE 7 AND TABLE 8,  $K_{D,FCR-N} = 0$  AND  $K_{D,FCR-D} = 8$ .



**FIGURE 51** FREQUENCY RESPONSE AFTER A 600 MW POWER STEP IN A SYSTEM WITH SEPARATE UNITS SUPPLYING FCR-N AND -D (ORANGE), AND A CONVENTIONAL REGULATOR SUPPLYING BOTH FCR-N AND -D (BLUE). PARAMETERS FROM TABLE 6, TABLE 7 AND TABLE 8, BUT WITH  $K_{D,FCR-N} = 8$  AND  $K_{D,FCR-D} = 0$ .



**FIGURE 52** FCR POWER RESPONSE AFTER A 600 MW POWER STEP IN A SYSTEM WITH SEPARATE UNITS SUPPLYING FCR-N AND -D (ORANGE), AND A CONVENTIONAL REGULATOR SUPPLYING BOTH FCR-N AND -D (BLUE). PARAMETERS FROM TABLE 6, TABLE 7 AND TABLE 8,  $K_{D,FCR-N} = 8$  AND  $K_{i,FCR-D} = 0$ .

### 3.2.2.1 SWITCHING OF ALL DYNAMIC PARAMETERS

To study a worst-case scenario all parameters have been switched (except droop) in the conventional regulator. In addition, a random imbalance is added to the power step, such that the frequency repeatedly crosses the threshold ( $\Delta f = 0.1 \text{ Hz}$ ). The simulation results in Figure 53 show that the impact of switching with a conventional regulator is marginal, even though there are a number of crossings of the threshold. Again, the settling time is reduced as the FCR-N response is activated with FCR-D parameters (which in this case is more aggressive). When the step response is balanced, after about 360 seconds, the impact of switching is marginal and negligible.

TABLE 10 PARAMETERS USED IN SIMULATIONS IN FIGURE 53.

Parameter	Value
$K_{p,FCR-N}$	4.436
$K_{i,FCR-N}$	0.2
$K_{D,FCR-N}$	0
$e_{p,FCR-N}$	0.06
$K_{p,FCR-D}$	10.436
$K_{i,FCR-D}$	4
$K_{D,FCR-D}$	8
$e_{p,FCR-D}$	0.06

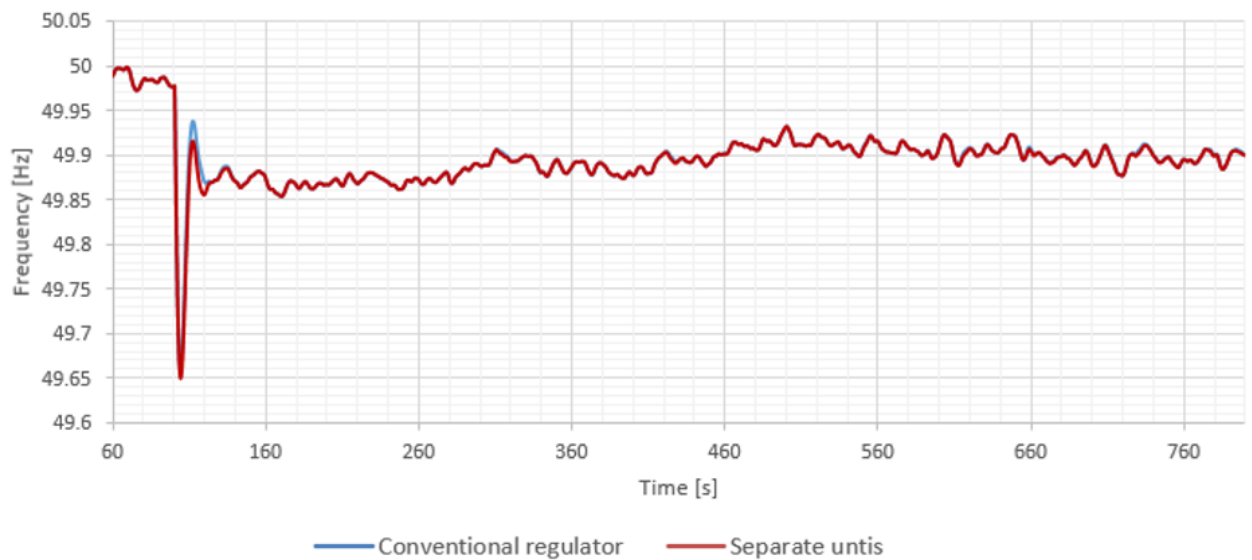


FIGURE 53 FREQUENCY RESPONSE IN A SYSTEM AFTER A POWER STEP AND RANDOM POWER CHANGES WHEN USING SEPARATE UNITS SUPPLYING FCR-N AND -D (ORANGE), AND A CONVENTIONAL REGULATOR SUPPLYING BOTH FCR-N AND -D (BLUE). PARAMETERS FROM TABLE 9.

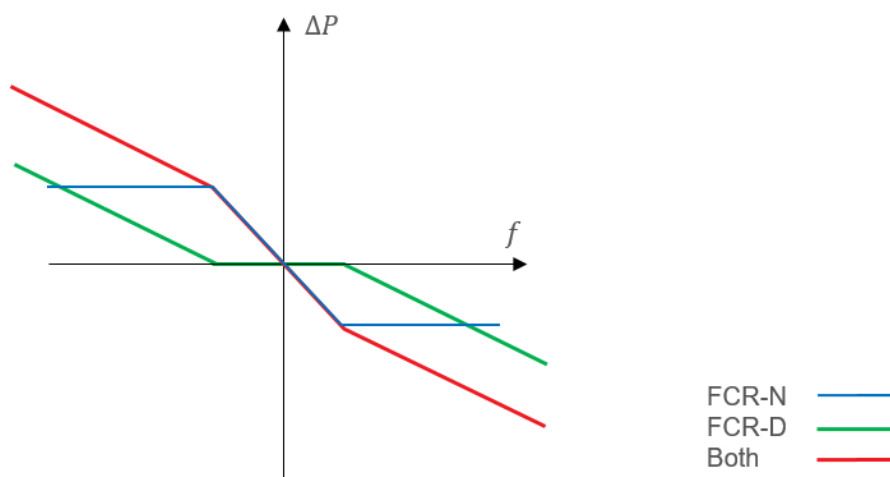
### 3.3 CONCLUSION

From the simulation results, it is conclusive that conventional switching is an intolerable solution if the droop is changed based on the impact of either increased steady state frequency deviation (when  $e_{p,FCR-N} < e_{p,FCR-D}$ ) or a limit cycle due to no equilibrium points (when  $e_{p,FCR-N} > e_{p,FCR-D}$ ). Simulations and analyses performed also show that a change of the PID-parameters doesn't have a severe impact on the frequency response. It should be noted that the simulations are based on a low inertia system, where a maximum amount of reserves are supplied from units with both FCR-N and -D delivery, and an imbalance bringing the steady state frequency to the switching threshold at 49.9 or 50.1 Hz. Seen in relation to the responses, which doesn't inflict any major problems in the system, it is recommended that switching of PID-parameters in a conventional regulator can be allowed.

### 3.4 REQUIREMENTS

The technical requirements for delivering both FCR-N and -D are;

- The operating point must allow activation of both FCR-N and -D according to the prequalification of them individually, and activation of FCR-N and -D must be within the operating range they are qualified for individually.
- For steady state FCR-delivery; A production unit delivering both FCR-N and FCR-D, shall deliver the sum of FCR-N and -D at any frequency deviation. With a threshold between FCR-products at  $\Delta f = 0.1$  Hz, this means that  $\Delta P(\Delta f_{FCR-N} = 0.1^- \text{ Hz}) = \Delta P(\Delta f_{FCR-N} = 0.1^+ \text{ Hz})$ . This is exemplified in Figure 54.



**FIGURE 54** STEADY STATE ACTIVATION, DROOP PROFILE, OF FCR-N (BLUE), FCR-D (GREEN) AND BOTH (RED).

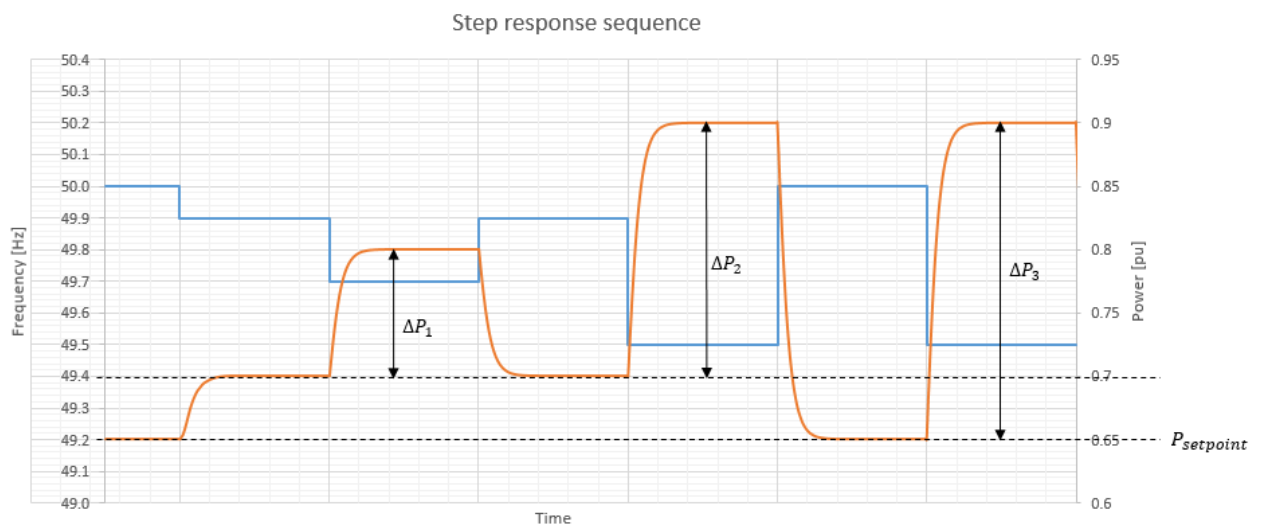
- There should be no intentional delays in the switching of parameters.
- The switching of the PID-parameters can be done in any arbitrary way, given that they comply with all other FCR-N and -D requirements. The TSOs have the right to ask for additional testing and/or simulations, if there are reason to believe that the relevant

turbine regulator configuration has any unforeseen dynamics disadvantageous for system stability. The TSO should conclude from the testing if the configuration is allowed or not.

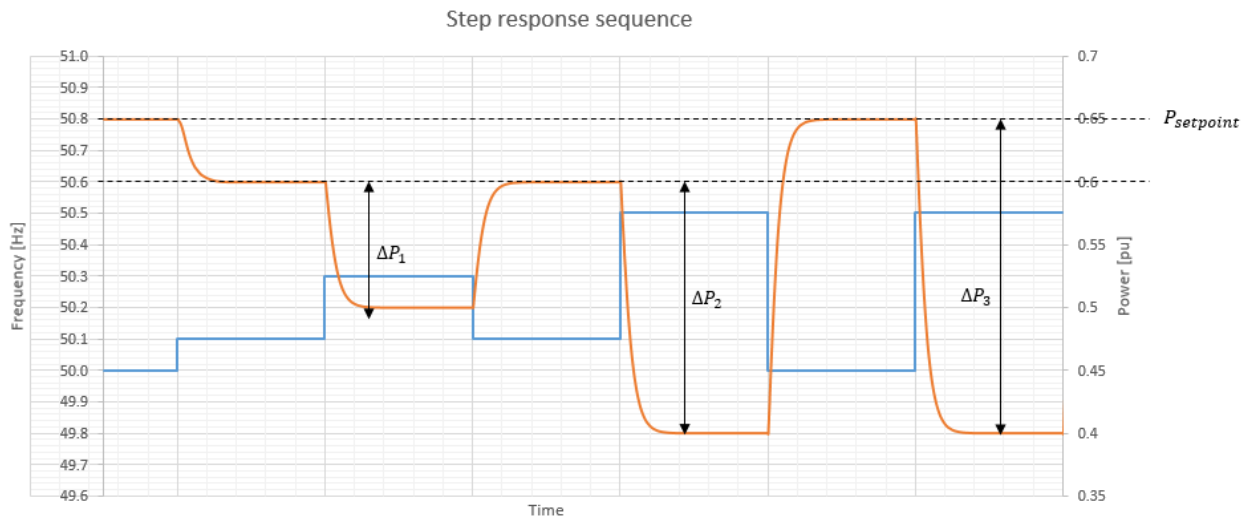
### 3.5 PREQUALIFICATION

For prequalification tests, it should be demonstrated that the unit can deliver both FCR-N and –D stationary. The requirement for entities delivering both FCR-N and FCR-D is that the entity shall be able to deliver the stationary capacity for both FCR-N and FCR-D simultaneously when a frequency step from 50 to 49.5 Hz or from 50 to 50.5 Hz is imposed. To test this an additional frequency step to the FCR-D test sequence shall be made. The values documented from the tests are shown in Figure 55 for upwards regulation and in Figure 56 for downwards regulation. The values from the figures are used to check the criteria, given as

$$|(\Delta P_2 + C_{\text{FCR-N}}) - \Delta P_3| < 0.05 * (\Delta P_2 + C_{\text{FCR-N}})$$



**FIGURE 55 EXAMPLE OF STEP RESPONSE FOR FCR-D UPWARDS REGULATION FOR DELIVERING BOTH FCR-N AND FCR-D**



**FIGURE 56 EXAMPLE OF STEP RESPONSE FOR FCR-D DOWNWARDS REGULATION FOR DELIVERING BOTH FCR-N AND FCR-D**



## 4. FULL-SCALE SIMULATIONS

### 4.1 INTRODUCTION

This chapter describes full-scale simulations performed using PSS/E simulation software in the FCR-Design project. The simulations were performed in order to assess the dynamic response of the Nordic power system using a detailed full-scale simulation model when revised technical requirements for the Frequency Containment Reserve for Disturbance (FCR-D) are being used.

The technical requirements for FCR-D were developed using a one machine equivalent model in MATLAB/Simulink. The goal of these full-scale simulations is to ensure that the power system responds in an acceptable way also when the dynamic response of the system is assessed with more detailed models.

The target for the study was to verify that the one machine model can be used to design the technical requirement for FCR-D by verifying in the full-scale simulation environment that the revised FCR-D does not cause any obvious problems that cannot be seen in the one machine model.

The most important information from the simulations is the instantaneous frequency minimum, i.e. the minimum frequency observed shortly after the disturbance and the damping of turbine governor mode oscillations. Turbine governor mode oscillations are power system oscillations caused by the activation of FCR-D which can be observed in the frequency having a time period of some tens of seconds. This report covers only FCR-D simulations as full-scale simulations of FCR-N were performed already in the previous project phase [8].

## 4.2 FULL-SCALE SIMULATION MODEL

The simulation model used for the studies is the full-scale Nordic PSS/E model<sup>4</sup> which is used for planning purposes and for studies requiring a detailed representation of power system components. The model contains about 2100 generators, 3400 loads, 8600 buses, 6300 branches between the buses (mostly power lines and sections of power lines in transmission and sub-transmission grids) and a number of shunts and HVDC-links. The full-scale simulation model includes detailed modeling of the dynamic behavior seen in a real power system whereas the one machine equivalent model is a simplified representation of the system (for example, it does not include modeling of voltage dynamics).

### 4.2.1 POWER SYSTEM STABILIZERS

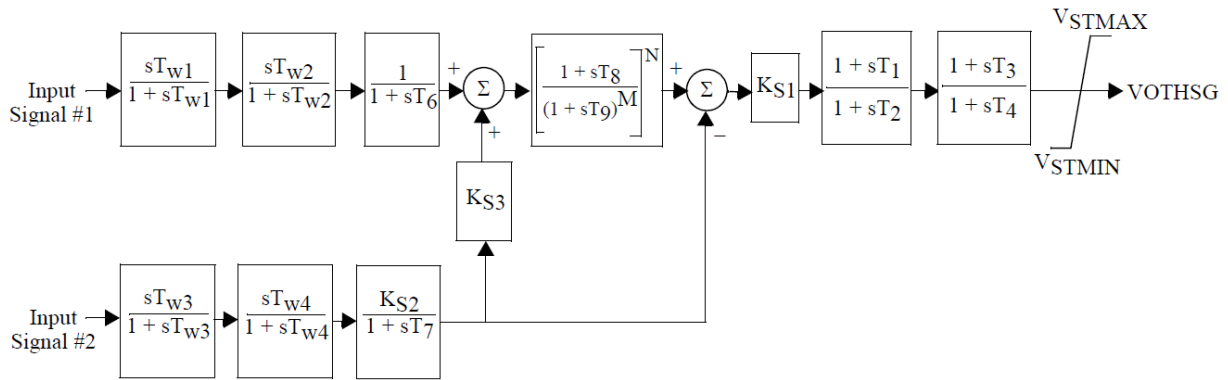
This section provides a brief background description of Power System Stabilizers (PSS).

In the full-scale simulation model Automatic Voltage Regulation (AVR) models are implemented together with the generator models. The purpose of the AVR is to control the excitation of the generator and thereby control the voltage at the generator terminal. An AVR provides voltage control but inherently decreases the small signal stability of electro-mechanical oscillations in the system. Electro-mechanical oscillations (inter-area oscillations) can occur between groups of generators over a weak connection. An example of such an oscillation is oscillations where generator groups in southern Sweden, southern Norway and eastern Denmark oscillate against generators in Finland with a frequency around 0.3 Hz [9]. Electro-mechanical oscillations have a much faster period time as compared to turbine governor mode oscillations. To increase the damping of electro-mechanical oscillations, an AVR can be complemented with a Power System Stabilizer (PSS). A PSS uses one or several external signals (typically measured electric power or grid frequency) in combination with filters to add an extra input signal to the AVR. A well-tuned PSS increases the damping of electro-mechanical oscillations. In the full-scale model a few types of PSS models are implemented. The PSS models and settings used in the simulations were not changed from the default implementation in the Nordic PSS/E model. Figure 57 shows the block diagram of *PSS2A*, one of the most common PSS in the Nordic PSS/E model. This PSS has the possibility to use two inputs. The output *VOTHS* in Figure 57 is used as an input to the AVR model. The tuning of the PSS may also affect the damping of the governor mode oscillations.

Electro-mechanical oscillations cannot be observed in the simplified Simulink model since it is a one mass model.

---

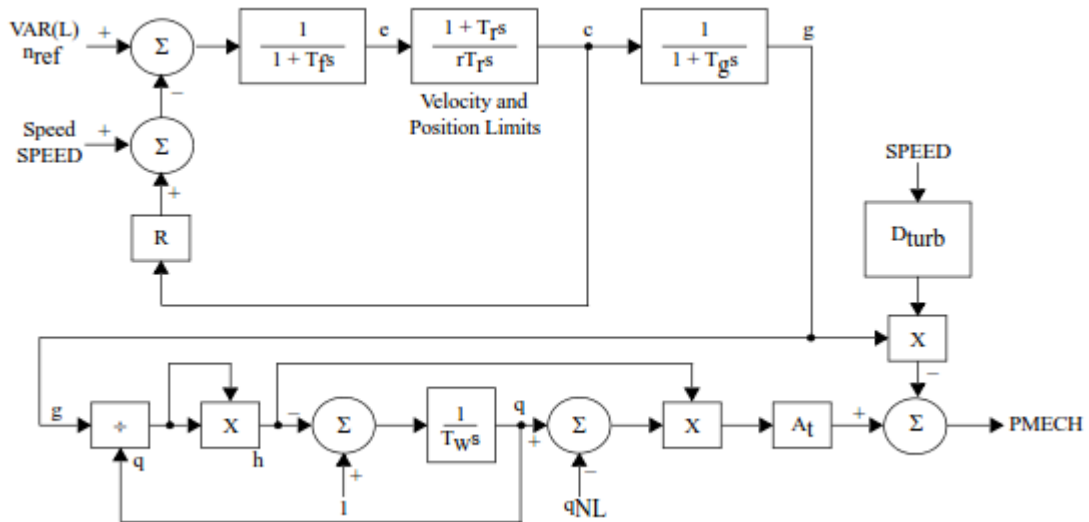
<sup>4</sup> Dynamics definitions version NordicModel2017



**FIGURE 57: COMMONLY USED POWER SYSTEM STABILISER (PSS) MODEL PSS2A IN THE NORDIC PSS/E SIMULATION MODEL [PSS/E 33.9 MODEL LIBRARY].**

### 4.2.2 MODEL UPDATES

The current Nordic PSS/E model was improved by replacing the *HYGOV* turbine governor model (Figure 58) with the more detailed *WEHGOV* turbine governor model (Figure 59 and Figure 60) as *WEHGOV* is better suited for modelling of modern digital turbine governors (*HYGOV* is suitable for old mechanical governors) [10]. Also, in Finland turbine governors were assigned only to units that are pre-qualified to provide FCR. Other turbine governor models than *WEHGOV* were removed. Special turbine governor models that do not contribute to FCR were kept unchanged (like specific models used to model power reduction due to voltage dips on some special units).



**FIGURE 58: HYGOV TURBINE GOVERNOR MODEL [PSS/E 33.8 MODEL LIBRARY].**

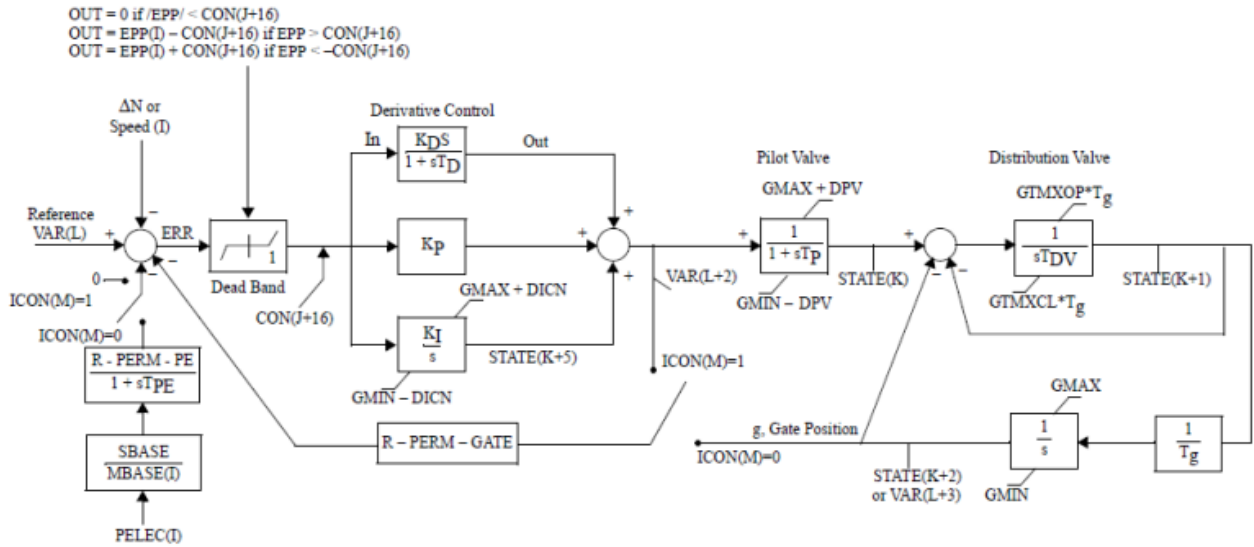


FIGURE 59: WEHGOV TURBINE GOVERNOR MODEL, GOVERNOR AND HYDRAULIC ACTUATORS PART [PSS/E 33.8 MODEL LIBRARY].

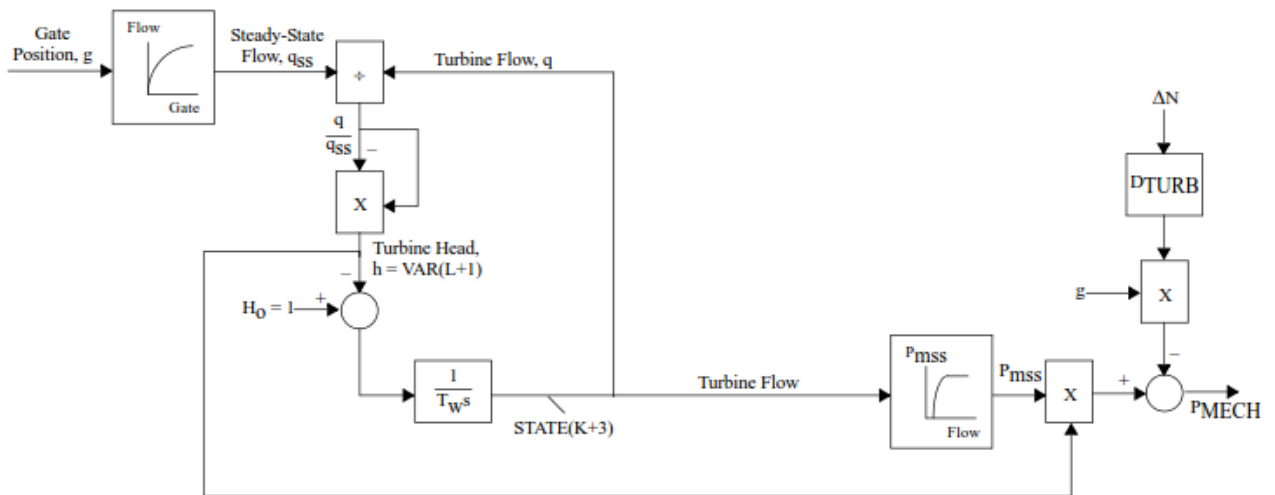
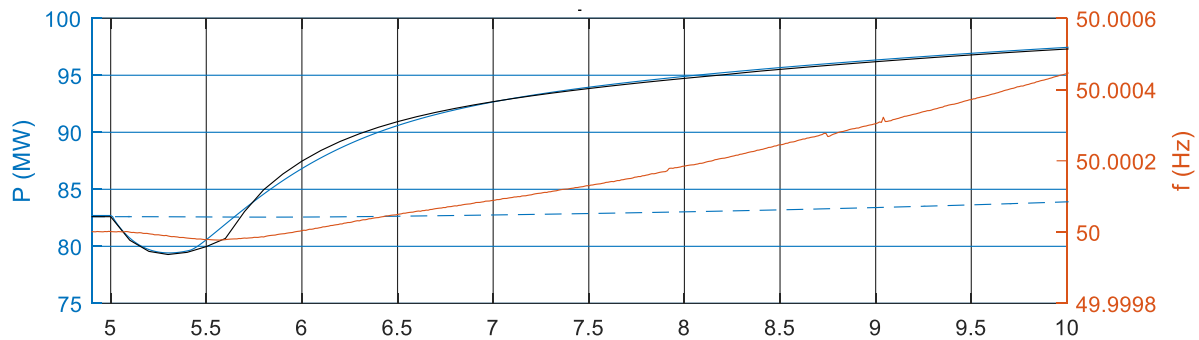


FIGURE 60: WEHGOV TURBINE GOVERNOR MODEL, TURBINE DYNAMICS PART [PSS/E 33.8 MODEL LIBRARY].

The governor and hydraulic actuators part of the *WEHGOV* model was tuned to give a similar response as the governor and servo model used in the simplified one machine model [1]. This was done by choosing a distribution valve time constant of zero, selecting high ramp-rate limiters, selecting high saturations limits and choosing zero pilot valve time constant. Furthermore, linear gate-flow relationship and linear flow- $P_{mech}$  relationship were assumed.

Multiple simulations were performed to verify that the *WEHGOV* PSS/E model gives similar response as the one machine Simulink model. An example of such a comparison can be seen in Figure 61. In the figure, the unit's mechanical power in PSS/E is shown by the solid blue curve and the mechanical power in the simplified model is shown by the solid black curve. Dashed blue curve and solid orange curve are unit's electrical power and terminal frequency in PSSE, respectively (electrical power does not change as unit's inertia constant was changed to a very high value in order for the power response not to affect the terminal frequency fed to the turbine governor).



**FIGURE 61: COMPARISON OF ONE UNIT'S RESPONSE TO -0.5 Hz STEP IN FREQUENCY REFERENCE IN PSS/E AND IN THE SIMPLIFIED MODEL.**

As the figure shows, the power responses match well. The minor differences that can be seen are likely caused by a slightly different servo modelling and differences in the numerical solver algorithms.

Furthermore, existing *LDFR\** models that provide load frequency dependence were replaced by *IEEL\** load models that provide both load voltage and load frequency dependencies. With *IEEL\**, load conversion before running dynamic simulations is unnecessary and it is easier to adjust load characteristics like frequency dependence.

### 4.2.3 MODEL PARAMETERIZATION

Two different sets of parameters modelling the FCR-D response were used in the simulations, see Table 11.

TABLE 11: TURBINE GOVERNOR PARAMETERS USED

	Parameter set 1	Parameter set 2
<b><math>R_{perm}</math> (droop)</b>	0.06	0.06
<b>Feedback type</b>	Gate	Gate
<b><math>T_{PE}</math></b>	0	0
<b><math>K_P</math></b>	7	2
<b><math>K_I</math></b>	3	3
<b><math>K_D</math></b>	0	0
<b><math>T_D</math></b>	0.1	0.1
<b><math>T_P</math></b>	0	0
<b><math>T_{DV}</math></b>	0	0
<b><math>T_g</math></b>	0.2	0.2
<b><math>GTMXOP</math></b>	0.1	0.1
<b><math>GTMXCL</math></b>	-0.1	-0.1
<b><math>GMAX</math></b>	1	1
<b><math>GMIN</math></b>	0	0
<b><math>D_{TURB}</math></b>	0	0
<b><math>T_w</math></b>	1.2	1.8
<b><math>DBAND</math></b>	0	0
<b><math>DPV</math></b>	10	10
<b><math>DICN</math></b>	10	10

Parameter set 1 was tuned to obtain a response that will qualify for both the performance and stability requirements from FCR-D design of requirements version 1 (both requirements are dimensioned for a 120 GWs kinetic energy system) [1]. Parameter set 2 is selected to simulate parameters not qualifying for the performance and stability requirement with full capacity in a 120 GWs system in order to illustrate the difference to parameters that qualify for the requirements. Parameter set 1 qualifies the performance requirement with 100 % capacity while parameter set 2 only qualifies 44 % of the reference performance. The steady state activation is the same for both parameter sets. The reduction of capacity is based on the amount of power and energy delivered during the first five seconds. Stability of these two parameter sets is shown in Figure 62 for a system of 120 GWs (capacity scaling from [1] is not included in the stability evaluation.).

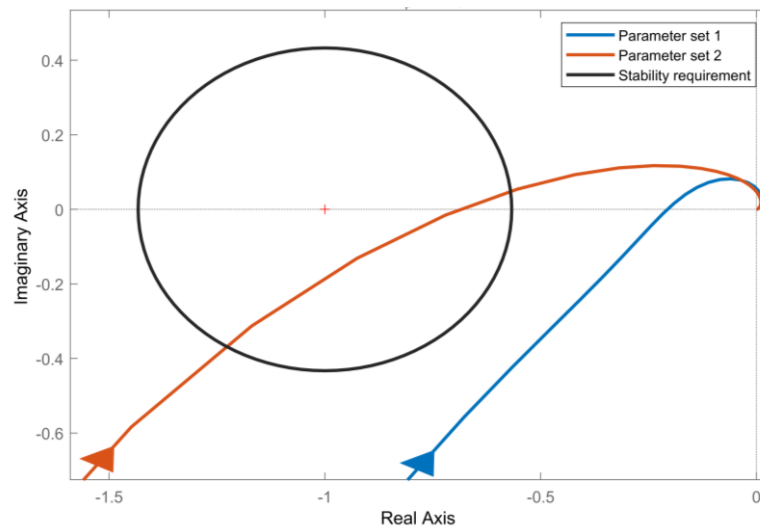


FIGURE 62: NYQUIST DIAGRAM FOR PARAMETER SET 1 AND 2 FOR A 120 GW SYSTEM

As the figure shows, parameter set 1 fulfils the stability requirement but parameter set 2 is not qualified for stability even without taking capacity scaling into account.

The following regulating strength distribution was used for FCR-D:

FI	297.3 MW/Hz	(8.2%)
SE	1283.0 MW/Hz	(35.4%)
NO	2041.2 MW/Hz	(56.4%)
Total	3621.5 MW/Hz	

A load frequency dependence of 0.5 % / Hz was used for all active power loads in the system. The load frequency dependence of reactive power loads was assumed to be zero. Parameters for the load voltage dependence are given in Table 12. Equations of the load voltage dependency used are:

$$P = P_{Load}(a_1V^0 + a_2V^1 + a_3V^2)$$

$$Q = Q_{Load}(a_4V^0 + a_5V^1 + a_6V^2)$$

$a_1$ -  $a_6$  represents the share of the specific load type, specified in Table 12.

**TABLE 12: LOAD VOLTAGE DEPENDENCE PARAMETERIZATION.  $V^0$  STANDS FOR CONSTANT POWER LOADS,  $V^1$  FOR CONSTANT CURRENT LOADS AND  $V^2$  FOR CONSTANT ADMITTANCE LOADS.**

Country	Active power load characteristic	Share of P-load [%]	Reactive power load characteristic	Share of Q-load [%]
Finland	$P(V^0)$	35	$Q(V^0)$	0
	$P(V^1)$	40	$Q(V^1)$	30
	$P(V^2)$	25	$Q(V^2)$	70
Sweden	$P(V^0)$	60	$Q(V^0)$	10
	$P(V^1)$	0	$Q(V^1)$	0
	$P(V^2)$	40	$Q(V^2)$	90
Norway	$P(V^0)$	20	$Q(V^0)$	20
	$P(V^1)$	40	$Q(V^1)$	40
	$P(V^2)$	40	$Q(V^2)$	40
Eastern Denmark	$P(V^0)$	35	$Q(V^0)$	0
	$P(V^1)$	40	$Q(V^1)$	30
	$P(V^2)$	25	$Q(V^2)$	70



## 4.3 STUDIES PERFORMED

In the simulations, a sudden power imbalance is caused by disconnecting a large production unit or an HVDC-link from the power system. The disturbances are simulated as a disconnection from the grid without an initial AC fault (short circuit or earth fault). Simulations are performed using two low inertia systems typical for summer weekends. The power flow cases are further specified in section 4.3.2. Total kinetic energy in the power system in both of the two cases is 145.5 GWs.

### 4.3.1 DISTURBANCES

Disturbances in the studies are chosen to represent the largest units in the Nordic power system in the coming years. Trips of units in southern Sweden, southern Finland and southern Norway are simulated both in the simplified Simulink model and in the full scale PSS/E simulation model. In this way it is possible to compare the results of the models and observe differences between the models and also locational differences in the PSS/E.

The active power production level for all three disturbances are set equal. However, the kinetic energy will be different after the trip depending on the disturbance. Table 13 describes the power and kinetic energy used for the three simulated disturbances.

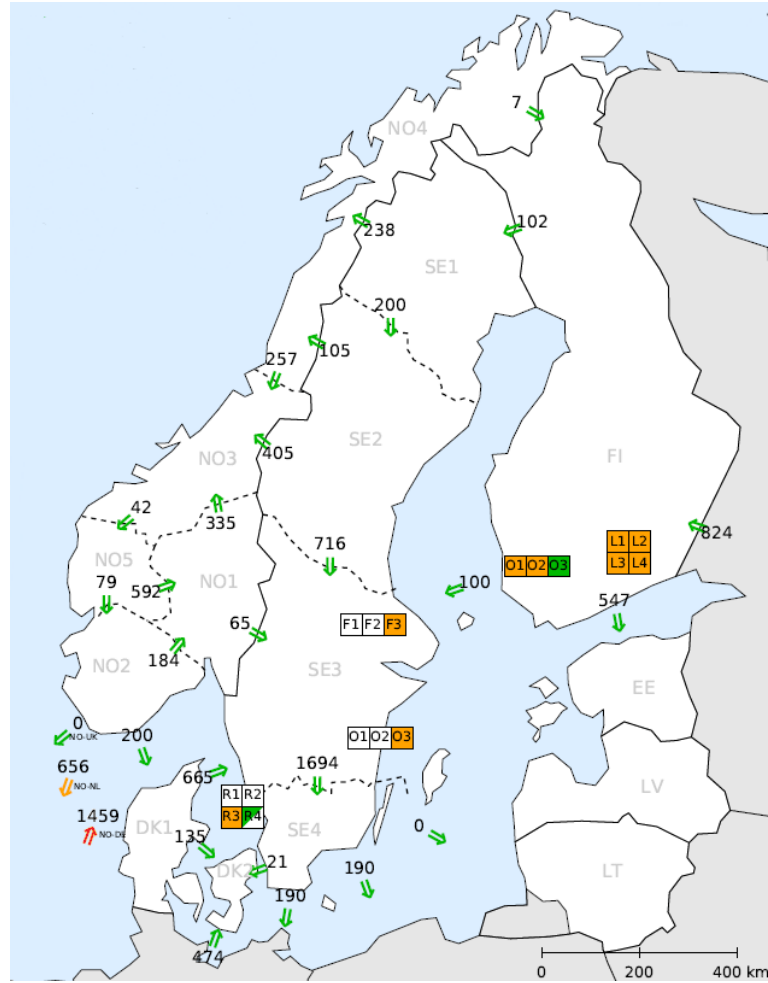
TABLE 13: SIMULATED DISTURBANCES.

	Active power [MW]	Unit kinetic energy [GWs]
<b>Southern Sweden</b>	1459	≈10
<b>Southern Finland</b>	1459	≈15
<b>Southern Norway</b>	1459	0

### 4.3.2 POWER FLOWS

The full-scale simulations are performed for two different power flow cases in order to observe if the frequency response changes with the loading of the power system. Both cases use the same generating units and the total load in the system is similar. The main difference is the import/export on the HVDC-links. In Case 1 the exports from Sweden and Denmark to the central European system are low and at the same time Finland is exporting power to Estonia. This results in low AC power flows internally in the Nordic power system as can be seen in Figure 63. In the figure, the operation of the nuclear power plants can be seen in Sweden and Finland: White means no production, green is production between 0-90% of maximum power and yellow is production over 90 %.

In Case 2 Finland is importing from Estonia and the export to the central European power system is increased in order to achieve higher AC power flows in the Nordic power system without changing the load and the generation. The HVDC-links between Finland and Sweden, Fennoskan 1 and 2, are assumed to be out of operation in Case 2, resulting in higher export from Finland to Sweden via the northern AC lines (see Figure 64).



**FIGURE 63: ACTIVE POWER FLOWS IN CASE 1. THE VALUES ARE IN MW.**

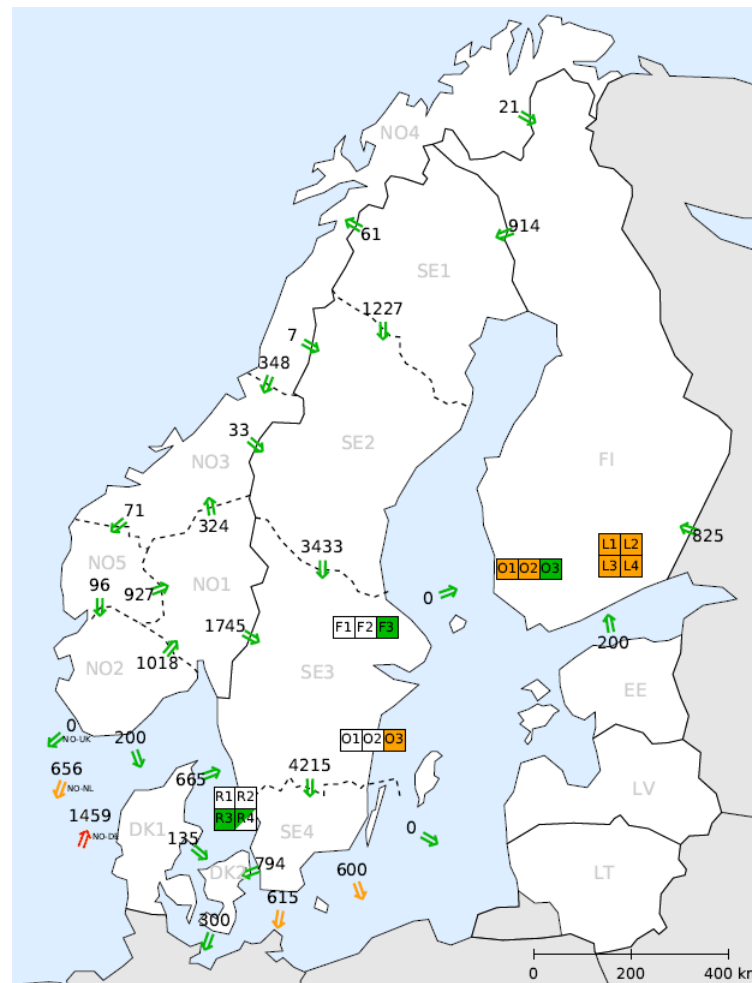


FIGURE 64: ACTIVE POWER FLOWS IN CASE 2. THE VALUES ARE IN MW.

Table 14 shows the system load and the average loading of the generating units contributing to frequency control.

TABLE 14: POWER SYSTEM LOAD AND AVERAGE UNIT LOADING

	Case 1	Case 2
System active power load [MW]	24 593	24 188
Average loading of generating units [%]	55.6	67.6

In the simplified Simulink model the average loading between case 1 and case 2 will be used as the unit's loading.

### 4.3.3 SIMULATIONS

In order to study the impact of load characteristics and PSS functions on the instantaneous frequency minimum and governor mode stability, simulations are performed using all possible combinations with the following settings on or off:

- Load frequency dependency
- Load voltage dependency
- PSS status

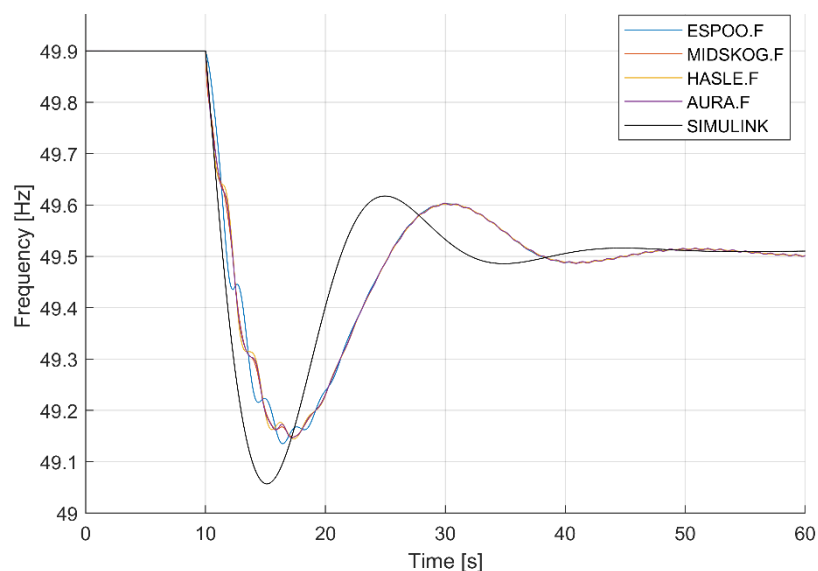
Settings for reactive power load frequency and load voltage dependence were not changed in the simulations. From here on the terms load frequency dependence and load voltage dependence refer only to the active power part.

Power system stabilizers and load voltage dependence is only included in the PSS/E simulation as it is not modelled in the simplified Simulink model. When changing the PSS it is only the status that is changed and not the parameters. The main objective with studying the PSS is the impact on the governor mode stability and not the electro-mechanical inter-area stability.

## 4.4 RESULTS

In total 96 simulations were performed using the full-scale PSS/E model. A summary of the results with regards to instantaneous frequency minimum and comparison to the results from the simplified model can be seen in Appendix 1. In Figures 9-16 the results from the different variations of PSS status and load dependence states are shown for Case 1 with Parameter set 1 using the disturbance in southern Sweden. The black line represents the simplified Simulink model while the blue, red, yellow and magenta lines represent four busses in the full-scale PSS/E model. Espoo is in Finland, Midskog is in Sweden and Aura and Hasle are in Norway.

Figure 65 shows the frequency response<sup>5</sup> in the base case where both load voltage and load frequency dependence as well as PSS functionality are activated. In this case the instantaneous frequency minimum in the full-scale simulation model is higher compared to the simplified model. The damping of the governor mode oscillations are roughly the same.

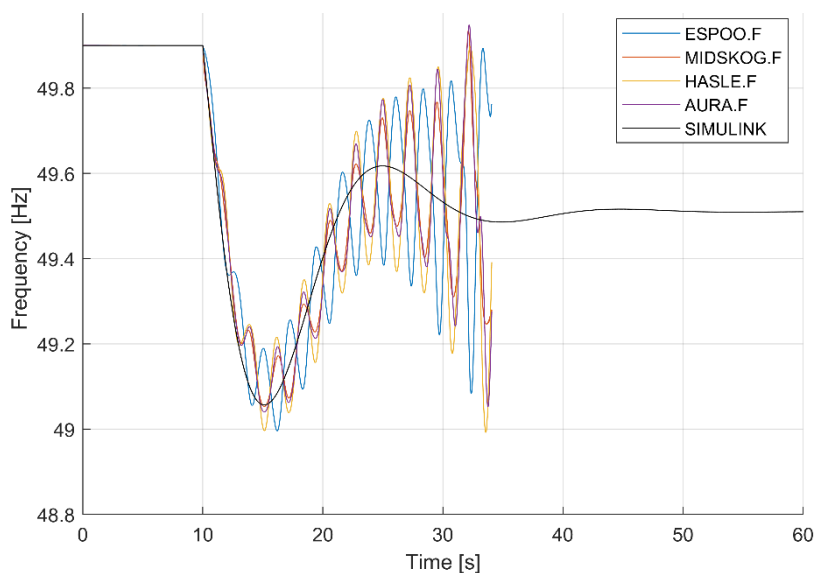


**FIGURE 65: FREQUENCY RESPONSE COMPARISON FOR CASE 1, PARAMETER SET 1, DISTURBANCE: SOUTHERN SWEDEN, FREQUENCY DEPENDENCY: ON, VOLTAGE DEPENDENCY: ON, PSS: ON.**

Figure 66, Figure 68, Figure 70 and Figure 72 show simulations when the PSS function is deactivated on all units. In all these four cases the system becomes unstable due to electro-mechanical inter-area oscillations and the simulation is interrupted. This shows the importance of well-tuned PSSs' to minimize the electro-mechanical oscillations and keep the system stable in the event of a major

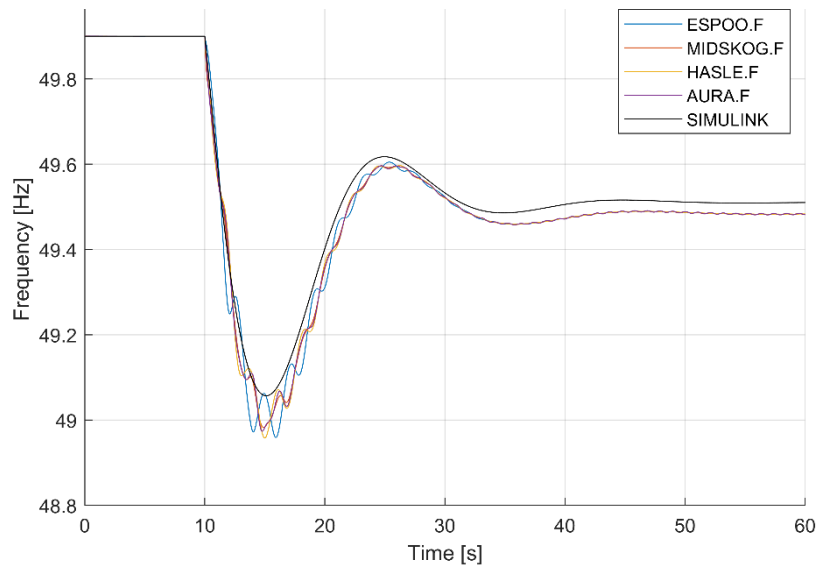
<sup>5</sup> A difference in instantaneous frequency minimum of  $\Delta f_{min} = 0.1 \text{ Hz}$  for a low inertia system roughly corresponds to a power difference of  $\Delta P = 120 \text{ MW}$  for the dimensioning incident [1]

frequency disturbance. The tuning of the PSSs' will also affect the instantaneous frequency minimum a little, as can be seen by comparing the average instantaneous frequency minimum in Figure 65 and Figure 66.



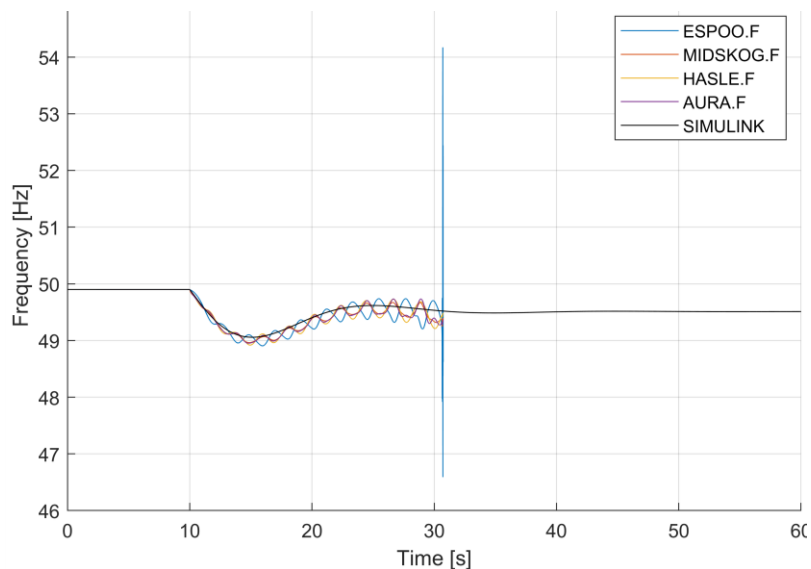
**FIGURE 66: FREQUENCY RESPONSE COMPARISON FOR CASE 1, PARAMETER SET 1, DISTURBANCE: SOUTHERN SWEDEN, FREQUENCY DEPENDENCY: ON, VOLTAGE DEPENDENCY: ON, PSS: OFF.**

Figure 67, Figure 68, Figure 71 and Figure 72 show the simulations without load voltage dependence. Figure 67 and Figure 71 show a similar result compared to the simplified model. Load voltage dependence is not included in the simplified model so the load should respond in a similar way in both simulation models. The steady state frequency deviation differs between the PSS/E model and the simplified model even though the load should behave in the same way. One reason for this is that the simplified model uses the average power set-point of 55.6 % on FCR providing units while in the PSS/E some units are close to 100 % loading. As a result of this high loading some units in the PSS/E model will be saturated during the simulation. This means that both simulation models have a regulating strength of 3621.5 MW/Hz at the start of the simulation, but when generators contributing to FCR-D in the PSS/E model reach 100 % and saturate, their contribution with further power increase will be zero. To conclude; the regulating strength in the PSS/E model will be reduced while it will stay the same in the simplified model.



**FIGURE 67: FREQUENCY RESPONSE COMPARISON FOR CASE 1, PARAMETER SET 1, DISTURBANCE: SOUTHERN SWEDEN, DEPENDENCY: ON, VOLTAGE DEPENDENCY: OFF, PSS: ON.**

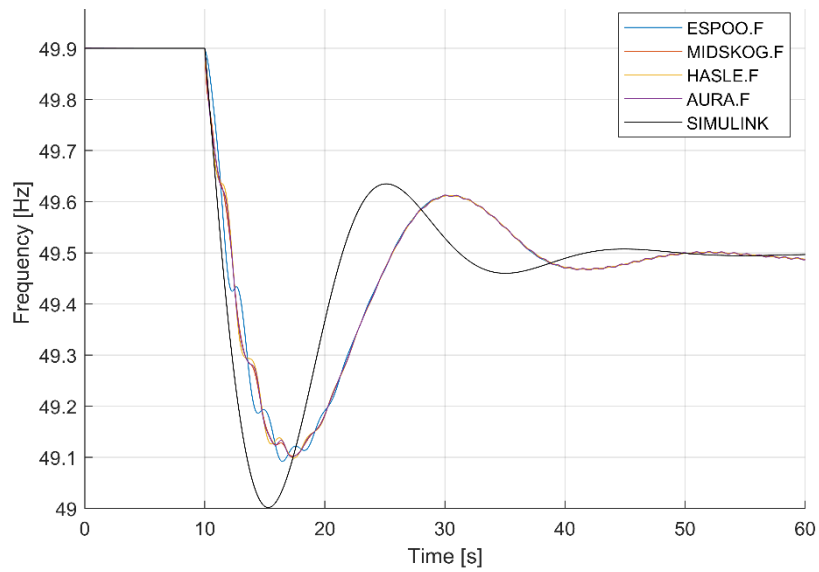
**FREQUENCY**



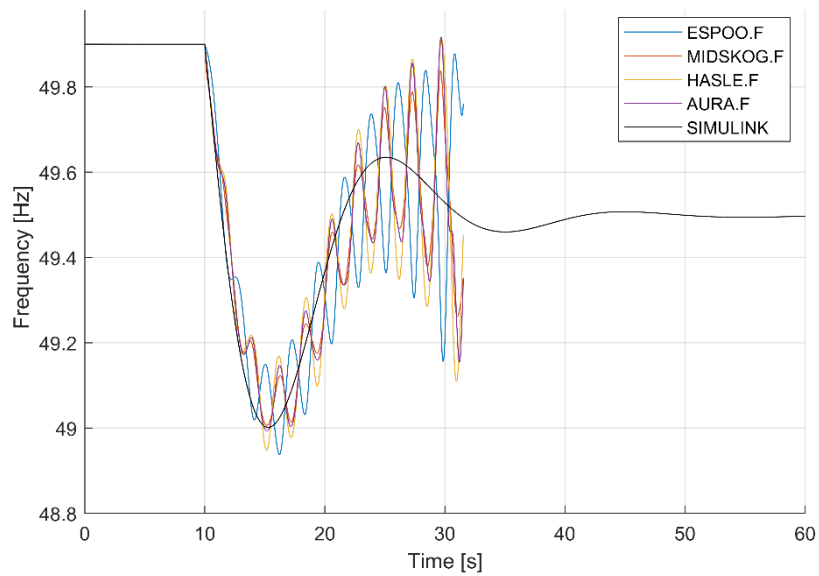
**FIGURE 68: FREQUENCY RESPONSE COMPARISON FOR CASE 1, PARAMETER SET 1, DISTURBANCE: SOUTHERN SWEDEN, DEPENDENCY: ON, VOLTAGE DEPENDENCY: OFF, PSS: OFF .**

**FREQUENCY**

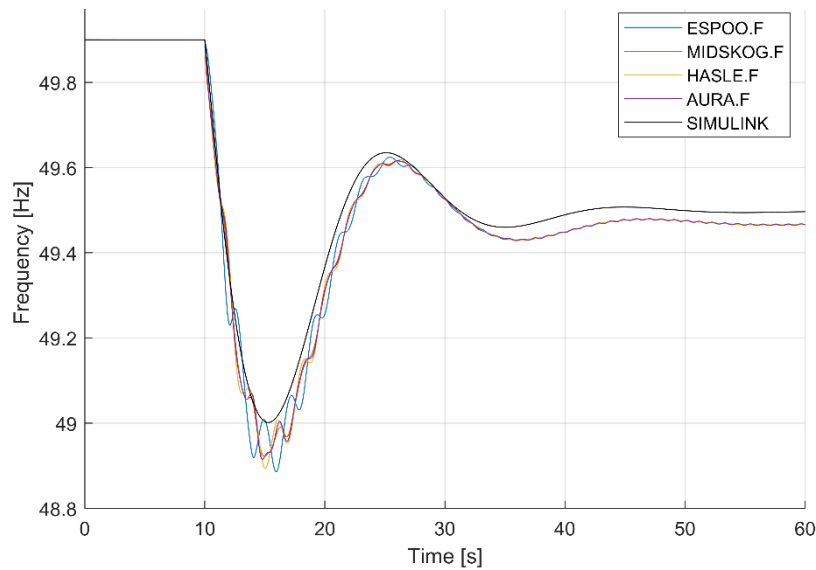
Figure 69, Figure 70, Figure 71 and Figure 72 show simulation results without load frequency dependence. Since the load frequency dependence is modelled in both the full scale and simplified simulation model, the frequency in both models change in the same way when load frequency dependence is deactivated. Therefore, there are no observed differences between the PSS/E and the simplified model as a result from load frequency dependence.



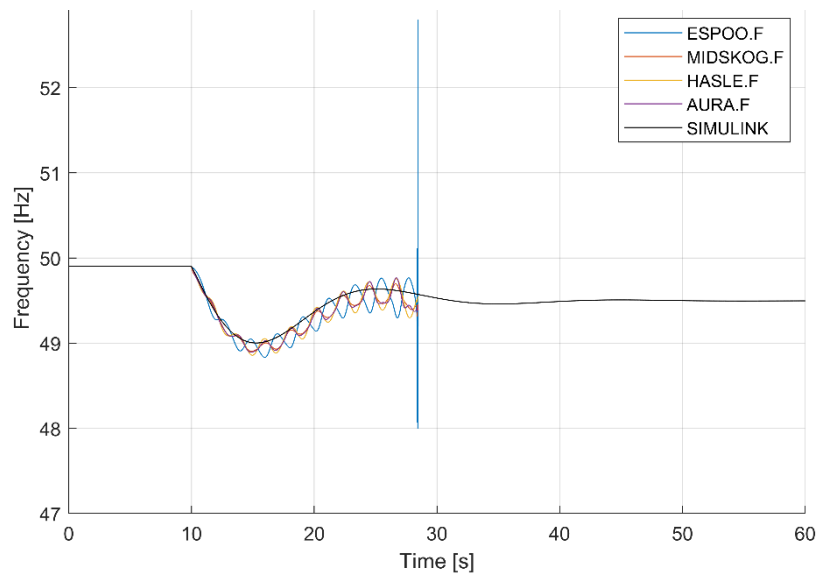
**FIGURE 69: FREQUENCY RESPONSE COMPARISON FOR CASE 1, PARAMETER SET 1, DISTURBANCE: SOUTHERN SWEDEN, FREQUENCY DEPENDENCY: OFF, VOLTAGE DEPENDENCY: ON, PSS: ON.**



**FIGURE 70: FREQUENCY RESPONSE COMPARISON FOR CASE 1, PARAMETER SET 1, DISTURBANCE: SOUTHERN SWEDEN, FREQUENCY DEPENDENCY: OFF, VOLTAGE DEPENDENCY: ON, PSS: OFF.**



**FIGURE 71: FREQUENCY RESPONSE COMPARISON FOR CASE 1, PARAMETER SET 1, DISTURBANCE: SOUTHERN SWEDEN, FREQUENCY DEPENDENCY: OFF, VOLTAGE DEPENDENCY: OFF, PSS: ON.**

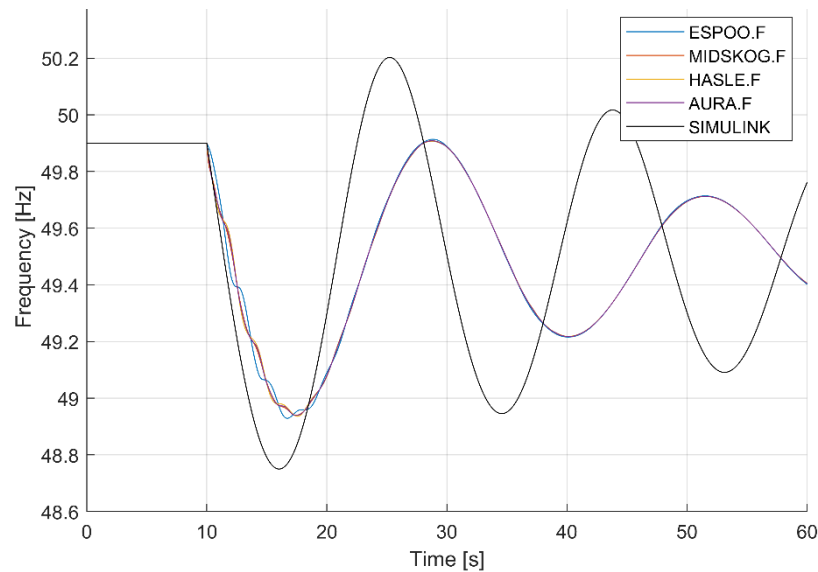


**FIGURE 72: FREQUENCY RESPONSE COMPARISON FOR CASE 1, PARAMETER SET 1, DISTURBANCE: SOUTHERN SWEDEN, FREQUENCY DEPENDENCY: OFF, VOLTAGE DEPENDENCY: OFF, PSS: OFF.**

Figure 73 and Figure 74 show the results for a simulation using parameter set 2, with lower stability margin. The kinetic energy in these simulations is approximately 130 GWs while the Nyquist diagram in Figure 62 is shown for 120 GWs.

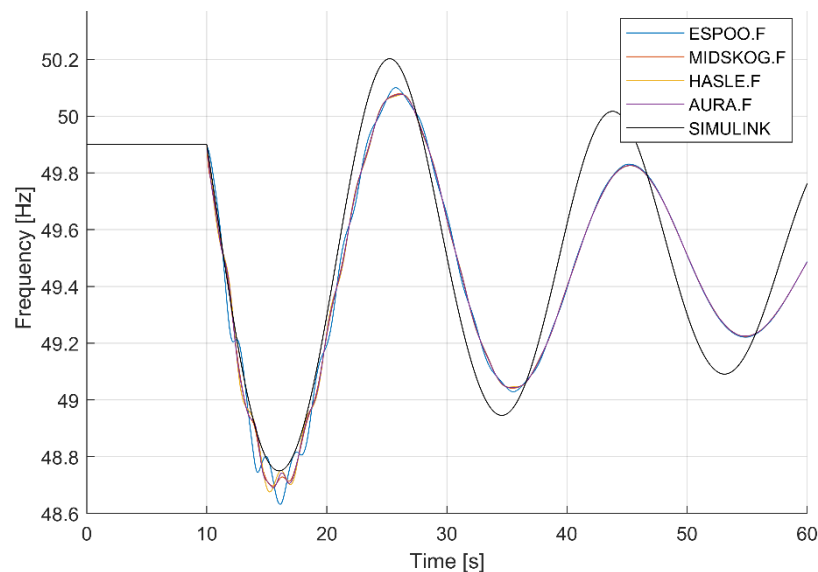
In Figure 73 both load voltage and frequency dependence as well as PSS functionality are activated. The instantaneous frequency minimum is higher in the PSS/E model as compared to the simplified Simulink model. Also the damping of the governor mode frequency oscillations is higher in the PSS/E model as compared to the simplified Simulink model.





**FIGURE 73: FREQUENCY RESPONSE COMPARISON FOR CASE 1, PARAMETER SET 2, DISTURBANCE: SOUTHERN SWEDEN, FREQUENCY DEPENDENCY: ON, VOLTAGE DEPENDENCY: ON, PSS: ON.**

Figure 74 shows the results when the load voltage dependence is deactivated. In this simulation the results are even more similar for the PSS/E and the Simulink models. The instantaneous frequency minimum is almost the same while the damping is still slightly better in the PSS/E model.



**FIGURE 74: FREQUENCY RESPONSE COMPARISON FOR CASE 1, PARAMETER SET 2, DISTURBANCE: SOUTHERN SWEDEN, FREQUENCY DEPENDENCY: ON, VOLTAGE DEPENDENCY: OFF, PSS: ON.**

For Case 2 convergence problems arose in the PSS/E simulations when simulating disturbances in southern Sweden and southern Norway when the load voltage dependence was deactivated.

A summary of the average impact of the load voltage dependence and the PSS functionality in the simulation results, with respect to instantaneous frequency minimum, is shown in Table 15. In the table a positive number means that the average instantaneous frequency minimum from simulations in the PSS/E model was higher as compared to simulations using the simplified Simulink model. Zero means that the average instantaneous frequency minimums in both models are equal. Due to convergence problems in the PSS/E model with case 2, results from case 2 are not included

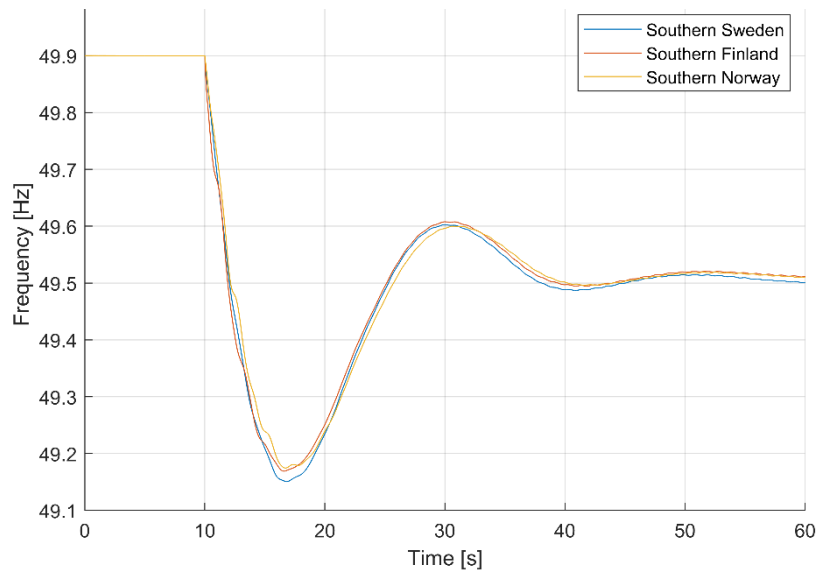
in the table. The convergence problems may either be the result of numerical issues during the simulations or voltage problems when solving the power flow. The instantaneous frequency minimum in PSS/E is calculated as an average value of the two nodes in Sweden, the one in Norway and the node in Finland to minimize the impact of electro-mechanical oscillations. It is not possible to see the combination effect of for example PSS and load voltage dependence in the table.

**TABLE 15: AVERAGE IMPACT OF LOAD VOLTAGE DEPENDENCY AND PSS FUNCTIONALITY ON THE INSTANTANEOUS FREQUENCY MINIMUM COMPARED TO THE SIMPLIFIED MODEL**

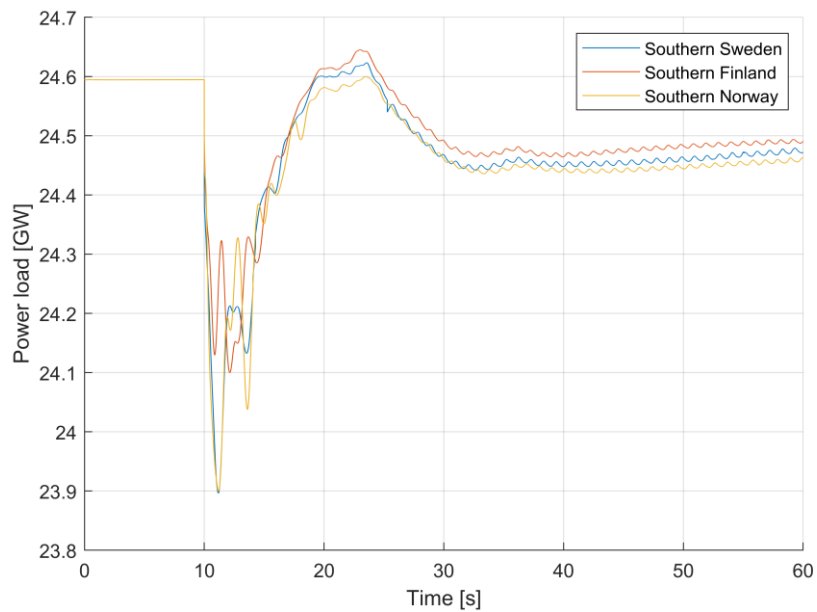
	<b>Case 1</b>
<i>Load voltage dependency – On</i>	+0.11 Hz
<i>Load voltage dependency – Off</i>	-0.06 Hz
<i>Load voltage dependency – Difference</i>	+0.17 Hz
<i>PSS – On</i>	+0.05 Hz
<i>PSS – Off</i>	-0.01 Hz
<i>PSS – Difference</i>	+0.06 Hz
<i>Load frequency dependency – On</i>	+0.02 Hz
<i>Load frequency dependency – Off</i>	+0.02 Hz
<i>Load frequency dependency – Difference</i>	+0.00 Hz

As the table shows, the load voltage dependence has the largest impact, the PSS second largest impact and the load frequency dependence has the lowest impact. When the load voltage dependence is turned off the instantaneous frequency minimum in the PSS/E simulation will be 0.06 Hz lower as compared to the simulation in the simplified Simulink model. When the load voltage dependence is activated the instantaneous frequency minimum will be 0.11 Hz higher as compared to the simplified model, i.e. a total difference of 0.17 Hz. The total difference for PSS functionality is 0.06 Hz. The impact from the load frequency dependence is very small since it is included in both simulation models.

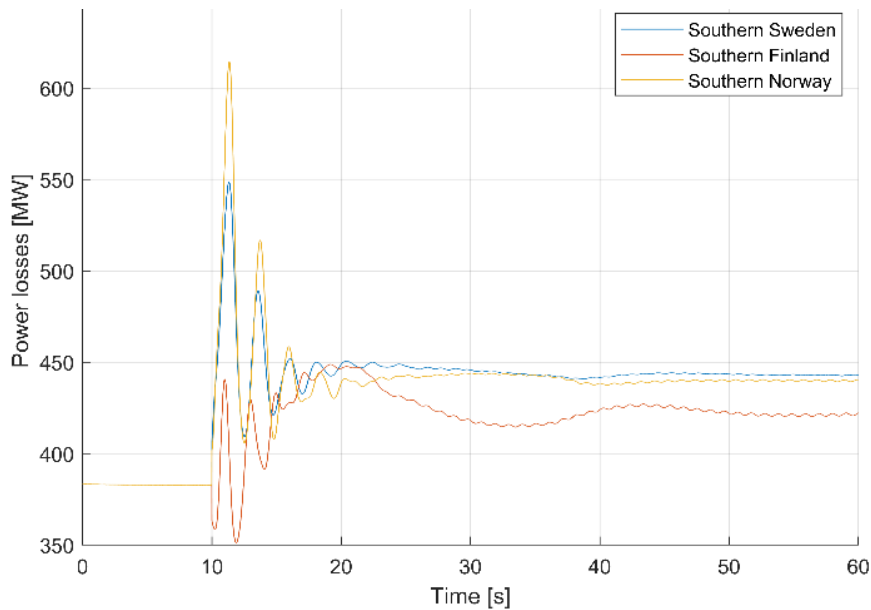
When comparing the results from the PSS/E simulations of the three different disturbances it is possible to see that in all cases and with all parameter set combinations the disturbance in southern Sweden has lower instantaneous frequency minimum as compared to the one in southern Finland. This is not expected since the disturbance in southern Finland is a more severe one, as can be seen in Table 13, because of the higher loss of kinetic energy. In the simplified Simulink model the instantaneous frequency minimum becomes lower for the disturbance in southern Finland as compared to southern Sweden and southern Norway. Figure 75 shows the frequency responses for the three disturbances from the PSS/E simulations. The instantaneous frequency minimum occurs at approximately 17 seconds and the change of energy from the load and losses are almost identical for all three disturbances. This indicates that the difference in instantaneous frequency minimum does not originate from changes in load and losses. Figure 76 and Figure 77 shows how the active power load and the active power losses change during the disturbance, respectively. The load and losses are added and calculated as energy in Figure 78.



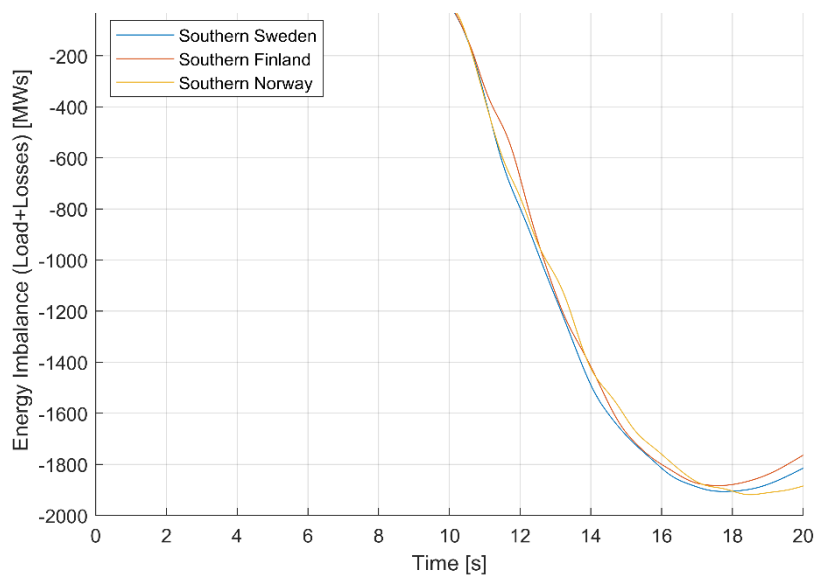
**FIGURE 75: FREQUENCY RESPONSE FOR CASE 1 WHEN THE DISTURBANCE OCCUR AT DIFFERENT LOCATIONS, PARAMETER SET 1, FREQUENCY DEPENDENCY: ON, VOLTAGE DEPENDENCY: ON, PSS: ON.**



**FIGURE 76: ACTIVE POWER LOAD FOR CASE 1 WHEN THE DISTURBANCE OCCUR AT DIFFERENT LOCATIONS, PARAMETER SET 1, FREQUENCY DEPENDENCY: ON, VOLTAGE DEPENDENCY: ON, PSS: ON.**

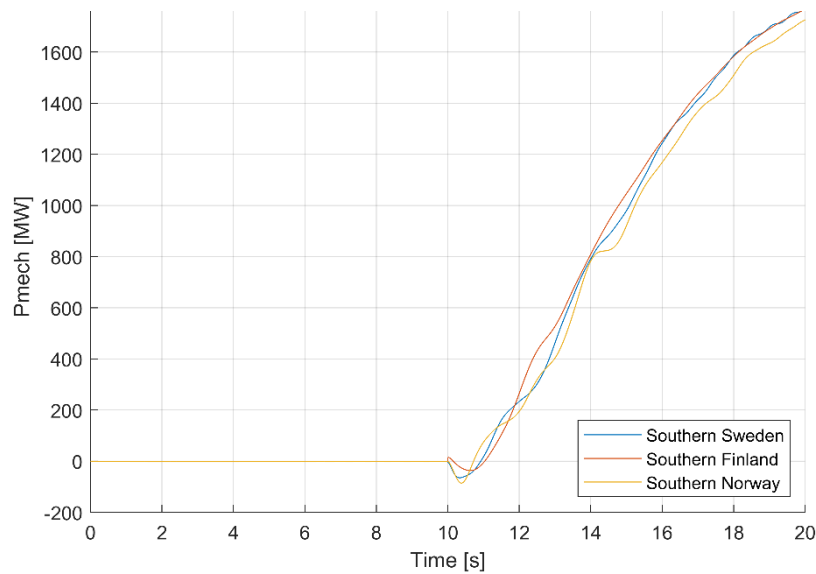


**FIGURE 77: ACTIVE POWER LOSSES FOR CASE 1 WHEN THE DISTURBANCE OCCUR AT DIFFERENT LOCATIONS, PARAMETER SET 1, FREQUENCY DEPENDENCY: ON, VOLTAGE DEPENDENCY: ON, PSS: ON.**

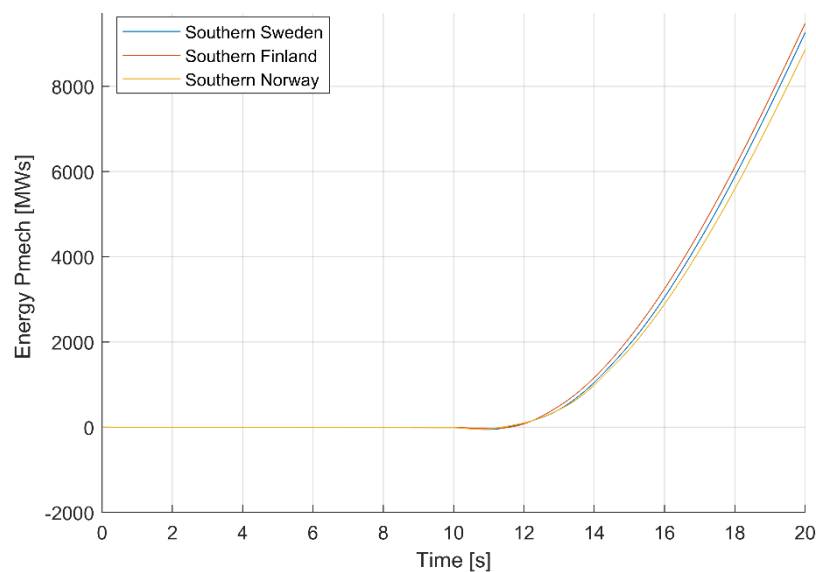


**FIGURE 78: ENERGY OF LOAD AND LOSSES FOR CASE 1 WHEN THE DISTURBANCE OCCUR AT DIFFERENT LOCATIONS, PARAMETER SET 1, FREQUENCY DEPENDENCY: ON, VOLTAGE DEPENDENCY: ON, PSS: ON.**

Figure 79 shows the total activated mechanical power from all units delivering FCR as a response to the frequency deviation. Figure 80 shows the calculated energy of the FCR delivery. Here it is possible to see that when the disturbance is in southern Finland, the FCR activation is faster as compared to when the disturbance is in the southern Sweden. So even if the disturbance in southern Finland is more severe, due to more loss of kinetic energy, compared to the one in southern Sweden, the instantaneous frequency minimum is higher.



**FIGURE 79: MECHANICAL POWER OF FCR FOR CASE 1, PARAMETER SET 1, FREQUENCY DEPENDENCY: ON, VOLTAGE DEPENDENCY: ON, PSS: ON.**



**FIGURE 80: MECHANICAL ENERGY OF FCR FOR CASE 1, PARAMETER SET 1, FREQUENCY DEPENDENCY: ON, VOLTAGE DEPENDENCY: ON, PSS: ON.**

The instantaneous frequency minimums for the disturbances in southern Finland and southern Norway are almost the same even though the kinetic energy is approximately 15 GWs higher for the disturbance in southern Norway. This is compensated with a faster FCR activation in this case for the disturbance in Southern Finland. The reason for the faster FCR activation when the disturbance occurs in southern Finland is not clear from the studies performed.

## 4.5 CONCLUSIONS

In this report, studies were performed to compare simulations of the simplified one machine equivalent Simulink model used to develop the requirements for the Frequency Containment Reserves for Disturbance to similar simulations in a full-scale PSS/E model. The simulations were performed using two simulation cases, two different FCR-D parameter sets for three different disturbances in southern Sweden, southern Finland and southern Norway. Load voltage and load frequency dependency and PSS functionality status were varied in the PSS/E model in order to see their impact on the frequency response.

The full-scale simulations indicate that introduction of revised FCR-D does not cause any obvious unforeseen issues and the power system behaves as expected with the revised FCR-D. Therefore, the simplified model can be considered as sufficient for the design of the technical requirements for FCR-D.

In all cases when load voltage and load frequency dependence as well as the PSS function were activated the instantaneous frequency minimum in the full-scale PSS/E model was higher as compared to the simplified model. The damping of the governor mode frequency oscillations was also always higher in the PSS/E model as compared to the simplified Simulink model.

Simulations with load voltage dependence deactivated and the PSS function activated gave the best agreement between the two simulation models.

Load voltage dependence has large impact on the instantaneous frequency minimum. With load voltage dependence deactivated the instantaneous frequency minimum will be 0.06 Hz lower as compared to the simplified model. When it is activated, the instantaneous frequency minimum will instead be 0.11 Hz higher as compared to the simplified model. The conclusion from the simulations performed of the different cases is that load voltage dependence is always beneficial for the instantaneous frequency minimum, irrespectively of where in the system the trip occurs.

The main purpose of a PSS is to increase the damping of the electro-mechanical oscillations in the system. This is seen during the simulations where the system in several cases becomes unstable when the PSS function is deactivated. If the PSS function is activated or not will also affect the instantaneous frequency minimum. The difference between the PSS on or off is 0.06 Hz.

The location of the disturbance in the system will have an impact on the frequency response. Even though the disturbance in southern Finland is losing more kinetic energy compared to the one in southern Sweden and southern Norway the instantaneous frequency minimum was higher as compared to the disturbance in southern Sweden and similar to the disturbance in southern Norway. This is due to the fact that the FCR-D response in this case is activated faster when the trip occurs in Finland as compared to Sweden or Norway.

## 5. CONCLUSIONS

The update of the FCR-D requirements performed in this FCR-Design project has basically been made using the same methodology as developed in the FCP project. The overall goal of this project has been to relax the FCR-D requirements developed in the FCP project to qualify sufficient hydro FCR-D capacity in all Nordic countries. The development of the requirements was made using a simplified one mass model in Simulink. Data from previously performed surveys has been used to give realistic parameter settings and distribution of parameters for the hydro units. The development of the requirements has been based on realistic data and assumptions. Some assumptions may be considered as conservative whereas other may be rather non-conservative. In total, it is the working group's opinion that the developed requirements are based on reasonable assumptions and therefore it is not recommended to operate the system outside the ranges used when developing the requirements.

Full scale simulations performed in PSS/E, using the full Nordic model including all production units and dynamic models, show a behaviour that is slightly better than the behaviour received when using the simplified Simulink model. This confirms that it is acceptable to use the simplified Simulink model for the development of the new FRC-D requirements.

The need for system kinetic energy to qualify requested FCR-D capacity using the given dimensioning requirements is roughly 300 GWs and this would require the use of the new FFR service during a large part of the time to ensure system transient frequency stability. This is most probably not an acceptable solution. Therefore, the final choice will be a trade-off between the qualified capacity from hydro power units in Finland and the needed FFR volume

In the FCR-D capacity studies made the large impact of the unit water time constant and loading of the unit have been demonstrated. Prequalification of capacity for a lower loading would significantly increase the qualified capacity. However, it is reasonable to assume that producers will prioritize the delivery of energy and therefore qualification for FCR-D will be based on typical operating ranges of the unit. A reduction of the water time constant is not realistic to make either, as this would require an increase of the tunnel area.

As can be seen from the studies on qualification of FCR-D capacity this is a challenge linked purely to Finland and consequently, solutions to the capacity challenge is strongly related to a solution of the Finnish situation. Already today Finland purchases parts of their FCR-D capacity from other sources than hydro. Therefore, this has already been considered as the dimensioning is based on that only 100 % FCR-D capacity from hydro units shall be qualified in Finland. If a further reduction of the Finnish FCR-D capacity from hydro could be made, either by having more FCR-D from other sources or by accepting that Finland buys FCR-D capacity from Sweden or Norway, the dimensioning system kinetic energy could be significantly reduced giving a more realistic solution, ensuring a FCR-D handling N-1 with a reasonable amount of FFR.

In the FCP project the development of the FCR-N requirements were thoroughly communicated with the stakeholders through several reference group meetings. Some proof of concept tests were also performed and together with previously performed tests the working group had a rather good understanding for the limitations when running in FCR-N mode. In this project there has been no reference group and no proof of concept tests as the project mainly was about to re-tune the requirements developed in the FCP-project, which was considered possible without engaging a large reference group.

Further on, the FCR-Design project deliveries will be followed up with a Nordic feasibility / CBA evaluation on implementation. After these evaluations, it is the aim to set a recommendation for technical requirements and by that update the project documentation.



## 6. REFERENCES

- [1] Robert Eriksson, Niklas Modig, Mikko Kuivaniemi, FCR-D design of requirements, 5.7.2017.
- [2] Nordic Analysis Group, NAG input to the project, 2018, Unpublished report.
- [3] 60s project phase 2, U-EAg-11-014-47A Report Survey (2), Unpublished report.
- [4] Appendix to FCR-D Design Report - updated capacity finnish units, Unpublished report
- [5] Supporting document for Technical Requirements for Frequency Containment Reserve, 26.06.2017.
- [6] E. Ørum, L. Haarla, M. Kuivaniemi, M. Laasonen, A. Jerkø, I. Stenkløv, F. Wik, K. Elkington, R. Eriksson, N. Modig and P. Schavemaker, Future System Inertia 2, 2017.
- [7] Technical Requirements for Frequency Containment Reserve Provision in the Nordic Synchronous Area, 26.062017.
- [8] M. Kuivaniemi and H. Kuisti, Full-scale simulations, 2017, Unpublished report
- [9] K. Uhlen, S. Elenius, I. Norheim, J. Jyrinsalo, J. Elovaara and E. Lakervi, Application of Linear Analysis for Stability Improvements in the Nordic Power Transmission System, IEEE, 2003.
- [10] IEEE, Dynamic Models for Turbine-Governors in Power System Studies, 2013.

## 7. APPENDIXES

Appendix 1: Simulation model and scripts used in the studies

Appendix 2: Updated  $T_w$  values for production units in Finland

Appendix 3: Script for capacity evaluation

Appendix 4: KPI tables

Appendix 5: Summary of PSS/E simulation results